

**LivaNova**

Health innovation that matters

# Heater-Cooler System 3T Operating Instructions



## Heater-Cooler System 3T • Operating Instructions

Copyright © 2007-2020  
LivaNova Deutschland GmbH  
Lindberghstrasse 25  
D-80939 Munich, Germany

Tel.: +49/(0)89/32301-0  
Fax: +49/(0)89/32301-555

All rights reserved, especially the right to reproduction and distribution as well as translation. No part of this document may be reproduced – by photocopy, microfilm or any other process – nor may any part of it be stored, edited, duplicated or distributed by electronic means without the written permission of LivaNova Deutschland GmbH.

Trademarks used in these operating instructions:

The name “Stöckert®” is a registered trademark.

Minnicare® is a registered trademark of the Minntech Corporation, a Cantel Medical Company.

Clorox® is a registered trademark of the Clorox Company.

Pall-Aquasafe™ is a registered trademark of the Pall Corporation.

CaviWipes™ and CaviCide™ are registered trademarks of Metrex Research, LLC.

### Indications for use

The Heater-Cooler System 3T is used to circulate water through heat exchangers to warm or cool a patient during cardiopulmonary bypass procedures lasting 6 hours or less.

Caution: Federal (U.S.A.) law restricts this device to sale by or on the order of a physician.

### Distributed in the U.S.A. by:

**LivaNova USA, Inc.**  
**14401 West 65th Way**  
**Arvada, CO 80004**

**phone: 800.221.7943**  
**phone: 303.425.5508**  
**fax: 303.467.6584**

Operating Instructions

Version 02/2020 - CP\_IFU\_16-XX-XX\_USA\_021

Firmware version No. 2.07

# Table of contents

<b>1</b>	<b>Introduction</b>	<b>5</b>
1.1	Introduction .....	6
<b>2</b>	<b>Safety</b>	<b>13</b>
2.1	Safety information .....	14
<b>3</b>	<b>System description</b>	<b>19</b>
3.1	General description .....	20
3.2	Structure of the heater-cooler .....	25
<b>4</b>	<b>Preparing the heater-cooler for a procedure</b>	<b>33</b>
4.1	General technical requirements .....	34
4.2	Conducting any required disinfection and maintenance .....	36
4.3	Connecting the procedural tubing .....	37
4.4	Connecting the potential equalization cable and the power supply .....	40
4.5	Connecting the aerosol collection set .....	42
4.6	Connecting to the S5/C5 System (if applicable) .....	49
4.7	Filling and mixing water tanks .....	50
<b>5</b>	<b>Using the heater-cooler during a procedure</b>	<b>57</b>
5.1	Positioning the heater-cooler in the OR .....	58
5.2	Connecting the procedural tubing to external devices .....	61
5.3	Powering on and checking the panel .....	63
5.4	Performing a functional check prior to operation .....	68
5.5	Priming the complete circuit .....	71
5.6	Using the device controls during a procedure .....	74
5.7	Completing a procedure .....	80

<b>6</b>	<b>Maintaining the heater-cooler</b>	<b>91</b>
6.1	General maintenance precautions . . . . .	92
6.2	Maintenance schedule and checklists . . . . .	94
6.3	Cleaning and disinfecting external surfaces, connectors, and fittings . . . . .	99
6.4	Disinfecting the water circuits every 14 days . . . . .	104
6.5	Monitoring the tank water . . . . .	125
6.6	Changing the water and adding hydrogen peroxide . . . . .	140
6.7	Preparing the heater-cooler for storage . . . . .	148
6.8	Cleaning the heater-cooler interior . . . . .	150
6.9	Replacing the tubings once a year . . . . .	152
<b>7</b>	<b>Technical specifications</b>	<b>153</b>
7.1	Specifications . . . . .	154
7.2	Icons and labels . . . . .	160
7.3	Part numbers . . . . .	164
7.4	Tested accessories . . . . .	166
7.5	Warranty . . . . .	166
7.6	Information on electromagnetic compatibility (EMC) according to IEC 60601-1-2 (4th edition) . . . . .	167
<b>8</b>	<b>Troubleshooting</b>	<b>175</b>
8.1	Control panel warnings and error code displays . . . . .	176
8.2	Troubleshooting or returning the 3T Aerosol Collection Set . . . . .	185

# 1 Introduction

**This chapter provides an overview of the device, including indications for use and contraindications. This chapter also provides an explanation of each chapter, technical terms and symbols used in this operating manual, and a definition of the filtered water required for use in the heater-cooler.**

# 1.1 Introduction

## 1.1.1 Device summary

**The Heater-Cooler System 3T is an independent 3-circuit-heating/cooling system which is suitable for continuous use.**

The heater-cooler has three circuits that you control from the control display panel:

- **Cardioplegia circuit**, whose temperature can be controlled from independent heating and cooling tanks.
- **Patient 1 circuit** and **patient 2 circuit**, which can be used with the oxygenator and/or the single-use heating/cooling blanket. The temperature for these two circuits can be controlled from one heating/cooling tank.

The heater-cooler is a non-sterile device. No part of the heater-cooler is provided sterile or can be sterilized.

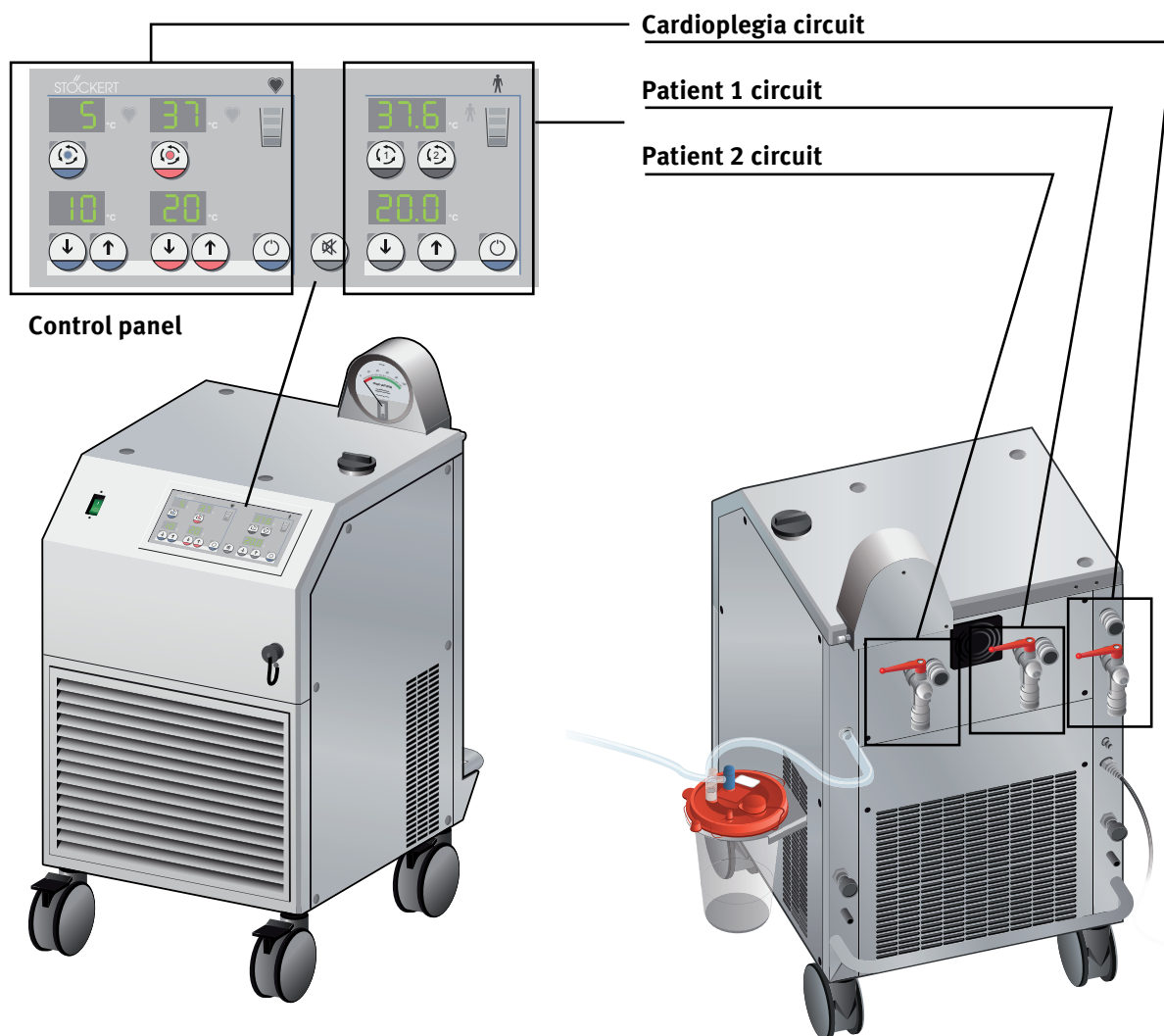

## 1.1.2 Indications for use

The Heater-Cooler System 3T is used to circulate water through heat exchangers to warm or cool a patient during cardiopulmonary bypass procedures lasting 6 hours or less.

## 1.1.3 Contraindications

There are no known contraindications for the Heater-Cooler System 3T. The attending physician is solely responsible for the use of the system.

## 1.1.4 Legal disclaimer

LivaNova Deutschland GmbH will not assume any liability for any injuries and/or damage to property caused by failure to observe the safety or operating instructions or by failure to exercise due care. This also applies even if the duty to exercise due care has not been expressly stated.

## 1.1.5 About these operating instructions

- These operating instructions are intended for clinical and maintenance personnel, and provide instructions for using, operating, and maintaining the Heater-Cooler System 3T.
- To ensure the safety of patients and the operators, read these operating instructions thoroughly before using the heater-cooler for the first time.
- These operating instructions provide valuable information. They describe operational steps and also contain information on how to avoid dangerous situations and errors. These operating instructions also provide troubleshooting instructions.

## 1.1.6 Symbols used in these operating instructions



### WARNING

Indicates a hazardous situation that, if not avoided, could result in death or serious injury.



### CAUTION

Indicates a hazardous situation that, if not avoided, could result in minor or moderate injury.

### NOTICE

Indicates a hazardous situation that, if not avoided, may result in damage to the device or other property.



### Important

Indicates information considered important but not hazard related.

**NOTE:** Provides additional information that can help you better understand a specific instruction of function.

- ✓ Checkmark: Used to indicate an item to check before or after completing a task. These items are for reference and do not replace detailed instructions.



## 1.1.7 The chapters in these operating instructions

### 1 Introduction

This chapter provides an overview of the device, including indications for use, contraindications. This chapter also provides an explanation of each chapter, technical terms and symbols used in this operating manual, and a definition of the filtered water required for use in the heater-cooler.

### 2 Safety

This chapter provides general safety information that you must follow to ensure safe and effective use. Additional safety information, such as Warnings and Cautions, are included throughout the instructions in this manual.

### 3 System description

This chapter describes the system's features and components, and the controls that you will use to control the system's circuits.

### 4 Preparing the heater-cooler for a procedure

This chapter provides instructions for preparing the heater-cooler for use.

## **5 Using the heater-cooler during a procedure**

This chapter provides instructions for positioning the heater-cooler in the OR and using the heater-cooler's controls during a procedure. This chapter also provides the basic steps you will conduct after a procedure.

## **6 Maintaining the heater-cooler**

This chapter provides instructions for the routine maintenance that is part of the operating conditions for the heater-cooler. This applies to the routine maintenance performed by the responsible organization as defined in IEC 60601-1 or the equivalent national standard, as well as to the preventive maintenance and safety checks performed by LivaNova representatives or competent service personnel.

## **7 Technical specifications**

This chapter provides technical specifications including information about the heater-cooler's physical characteristics, labeling, part numbers, accessories, and electromagnetic compatibility. This chapter also includes warranty information.

## **8 Troubleshooting**

This chapter provides troubleshooting for warnings and error codes you might see on the control panel, and troubleshooting related to the aerosol collection set.

## 1.1.8 Terminology and abbreviations

### Terminology

Abbreviated term	Full term
Heater-cooler	Stöckert Heater-Cooler System 3T
S5 System	Stöckert S5 System, modular heart-lung machine
C5 System	Sorin Compact 5 System, compact heart-lung machine
Aerosol collection set	3T Aerosol Collection Set

### Abbreviations

Abbreviated term	Full term
ACS	Aerosol Collection Set 3T
AL	Allowable Limit
CAN	Controller Area Network (CAN bus)
cc	Cubic centimeter (cm <sup>3</sup> )
CFU	Colony Forming Unit
EMC	Electromagnetic Compatibility
EPA Reg. No.	Registration number of the United States Environmental Protection Agency (applies to the United States only)
HC3T	Heater-Cooler System 3T
HLM	Heart-Lung Machine
L	Liters
LPM	Liters per minute
mL	Milliliters
NTM	Non-tuberculous Mycobacteria
OR	Operating Room
Pa	Pascal
kPa	Kilopascal
ppm	Parts per million
RF	Radio Frequency
UDI	Unique Device Identifier

## 1.1.9 Requirement for filtered tap water

**Tap water used to fill the heater-cooler must be filtered using the following filter and specifications:**

Disposable Pall-Aquasafe water filter with an 0.2 µm membrane (Pall part reference in the U.S.: “AQINA”; “AQIN” in other countries) or a filter of equivalent performance that meets the requirements for bacterial retention of *Brevundimonas diminuta* to  $\geq 10^7$  CFU/cm<sup>2</sup> of effective filtration area.<sup>1</sup>

For instructions on filter management and disposal after the specified use period please refer to the manufacturer’s instructions for use.

---

1 American Standard Test Method F838-15ae1 “Determining Bacterial Retention of Membrane Filters Utilized for Liquid Filtration”

# 2 Safety

**This chapter provides general safety information that you must follow to ensure safe and effective use.**

**Additional safety information, such as Warnings and Cautions, are included throughout the instructions in this manual.**

## 2.1 Safety information

### 2.1.1 General safety

- Read and understand the instructions for use before operating the heater-cooler.
- Disinfect the external surfaces and water circuits per chapter 6 prior to first use.
- Do not place any objects (including the portable vacuum source) on top of the heater-cooler.
- Maintain at least 70 cm clearance from walls and other devices while operating the heater-cooler to prevent the heater-cooler from overheating.
- Do not operate the heater-cooler in the presence of explosive substances.
- Do not modify any of the mechanical or electrical systems of the heater-cooler.
- Do not remove the side or rear panels of the heater-cooler. Contact with the internal components can cause serious injury or death.
- A list of approved accessory devices is contained in chapter 7. Do not use any unapproved accessory devices with the heater-cooler.
- Do not use self-closing tubing connectors or connectors that incorporate a valve. These connectors can reduce water flow to the external circuits.
- Drain heater-cooler water tanks outside the OR.
- Do not replace the aerosol collection canister in the OR environment.
- Avoid splashing heater-cooler water in the OR environment during use and when making water circuit connections.
- Remove water spills from the OR floor using suitable disinfectants as recommended by hospital procedures.
- Do not perform any maintenance activities while the heater-cooler is in use or connected to an oxygenator or other heat exchanger device.

## 2.1.2 Information on diffusion of hydrogen peroxide through the oxygenator heat exchanger

The water in the heater-cooler contains approximately 330 ppm of hydrogen peroxide when prepared per these operating instructions. Contact the manufacturer of the disposable oxygenator for information specific to the hydrogen peroxide permeability of the heat exchanger for concentrations at or below this level.

Do not use the heater-cooler with disposable oxygenators that have a heat exchanger with a permeability rate that exceeds the daily allowable limit (AL) as defined in the following table:

Duration of exposure to H <sub>2</sub> O <sub>2</sub>	Allowable limit (AL) in mg/day per kg of patient body weight	Allowable mass of hydrogen peroxide (H <sub>2</sub> O <sub>2</sub> ) in mg/day that can be transferred in patient blood for:	
		An adult (typical body weight is 60 kg)	A neonate (typical body weight is 3 kg)
Up to 6 hours	0.21	12.60	0.63
Over 6 hours	0.034	2.02	0.10

Although allowable limits (AL) for hydrogen peroxide diffusion are provided, actual performance may vary in individual cases. Monitor and manage all patients.

## 2.1.3 Procedural safety

- The heater-cooler does not monitor the temperature of the patient's blood or the cardioplegia solution.
- Do not empty the external circuits until the patient has been discharged from the OR.
- LivaNova recommends always having a replacement heater-cooler available in case the heater-cooler in use is no longer functional (e.g., due to a total system failure). The replacement heater-cooler must have compatible connectors.

## 2.1.4 Electrical safety

- Do not modify any of the electrical systems of the heater-cooler.
- The heater-cooler should only be connected to a hospital-quality power source with an integrated protective conductor (ground).
- To avoid the risk of electric shock, the heater-cooler must only be connected to a supply mains with protective earth.
- Check the condition of the power cable and plug regularly and do not use the heater-cooler if the cable or plug shows signs of wear or damage.
- Do not position the heater-cooler where it will block access to the mains power plug. Removing the mains plug from the receptacle isolates the heater-cooler from mains voltage and the plug must remain accessible at all times.

## 2.1.5 Integrating the HC3T into your facility

As part of the integration of the Heater-Cooler System 3T into your facility, LivaNova strongly recommends the following:

- Ensure that all operators and maintainers of the heater-cooler read the instructions and familiarize themselves with the use and maintenance of the device (chapters 4, 5 and 6), with special emphasis on the critical tasks listed in the table below.
- Integrate all maintenance activities listed in chapter 6.2.1 into your facility's preventative maintenance scheduling system. This includes the cleaning and disinfection of the heater-cooler before first use. Failure to perform the maintenance tasks as indicated can lead to bacterial growth inside the device and an increased risk of exposing the patient to harmful bacteria.
- Implement regular bacterial sampling of the water in the heater-cooler into your preventative maintenance scheduling system. This testing is critical to understanding if the disinfection and water preservation activities are being completed effectively. This testing can also indicate if an external source of contamination (e.g. a contaminated water hose) is present.



If you have any questions about the integration of the Heater-Cooler System 3T into your facility, please contact your LivaNova sales representative.

Human Factors Testing and clinical experience have shown that operators are most likely to have issues understanding or performing the critical tasks in the following table. This table provides the task description, where to locate the instructions related to this task, and the consequences of failing to perform the task correctly.

<b>Task</b>	<b>Location of instructions</b>	<b>Potential consequences of incorrect task performance or omission</b>
Do not use the HC3T without the ACS attached.	Chapter 4.5	Failure to use the ACS may result in the emission of aerosol.
Cap unused ports on the ACS.	Chapter 4.5 Task 3, ▣ 3	Failure to cap the tandem and pour ports may lead to a loss of vacuum in the ACS, potentially reducing the effectiveness in preventing the emission of aerosol.
Write the installation date on the ACS.	Chapter 4.5 Task 4, ▣ 7	Failure to write down the installation date can lead to use of the ACS beyond 7 days, potentially clogging the filter and reducing the effectiveness in preventing the emission of aerosol.
Replace the ACS after the disinfection procedure.	Chapter 6.4.2 Task 11	Failure to replace the ACS after the disinfection procedure could lead to disinfectant vapor entering the vacuum system.
Clean and disinfect the HC3T prior to first use.	Chapter 6.2.1	Bacteria may be present on or in the heater-cooler if the packaging was damaged during transport or storage.
Disinfect the connectors and tubing fittings prior to each connection.	Chapter 6.3.2 Chapter 6.3.3	Failure to disinfect the connectors and/or fittings could lead to bacterial growth that can be transferred to other parts of the heater-cooler or the OR.
Drain water tanks prior to adding disinfectant.	Chapter 6.4.2 Task 2	Failure to drain the tanks prior to adding disinfectant could reduce the disinfectant's effectiveness.
During disinfection, fill the water tanks to the Patient level second green LED after adding disinfectant.	Chapter 6.4.2 Task 4, ▣ 4	Failure to completely fill the tanks during disinfection could lead to a low level in one tank, potentially resulting in incomplete disinfection.
Circulate disinfectant by pressing the WARM CP, Patient 1, and Patient 2 buttons.	Chapter 6.4.2 Task 8, ▣ 1	Failure to circulate disinfectant using Patient 1, Patient 2, and the WARM CP buttons could lead to incomplete disinfection of one or more tanks.

Task	Location of instructions	Potential consequences of incorrect task performance or omission
Do not use disinfectant during a procedure.	Chapter 6.4.1	Use of disinfectant in the water during a procedure could lead to failure of the heater-cooler and the attached accessory devices.
Mix chemicals (disinfectant or hydrogen peroxide) by connecting a tube between the INLET of the CP circuit and the INLET of the Patient 1 circuit.	Chapter 4.7 Task 3 & 4 Chapter 6.4.2 Task 6 Chapter 6.6 Task 4 & 5	Failure to properly connect the tubing prior to mixing could lead to one or more tanks not being exposed to the correct amount of the chemical, potentially reducing the effectiveness of the water preservation process.
Mix chemicals (disinfectant or hydrogen peroxide) using the COLD CP button.	Chapter 6.4.2 Task 6, ▣ 1 and Task 6, ▣ 2	Failure to use the COLD CP button to mix disinfectant could result in insufficient exposure of one or more tanks to the required quantity of disinfectant.
Change the water in the heater-cooler every 7 days.	Chapter 6.2.1 Section 6.6	Failure to change the water can lead to ineffective prevention of bacterial growth.
Add 150 ml of 3% medical-grade hydrogen peroxide when filling the heater-cooler.	Chapter 4.7 Task 2, ▣ 3 Chapter 6.6 Task 3, ▣ 3	Failure to add hydrogen peroxide when filling the water tanks can lead to ineffective prevention of bacterial growth.
Performing the monthly bacterial monitoring procedure.	Chapter 6.5.2	Failure to properly sample the water in the heater-cooler can lead to an inability to identify potentially harmful levels of bacterial growth in the device.

# 3 System description

This chapter describes the system's features and components, and the controls that you will use to control the system's circuits.

## 3.1 General description

### 3.1.1 Device summary

The Heater-Cooler System 3T is an independent 3-circuit-heating/cooling system which is suitable for continuous use.

The heater-cooler has three circuits that you control from the control display panel:

- **Cardioplegia circuit**, whose temperature can be controlled from independent heating and cooling tanks.
- **Patient 1 circuit** and **patient 2 circuit**, which can be used with the oxygenator and/or the single-use heating/cooling blanket. The temperature for these two circuits can be controlled from one heating/cooling tank.

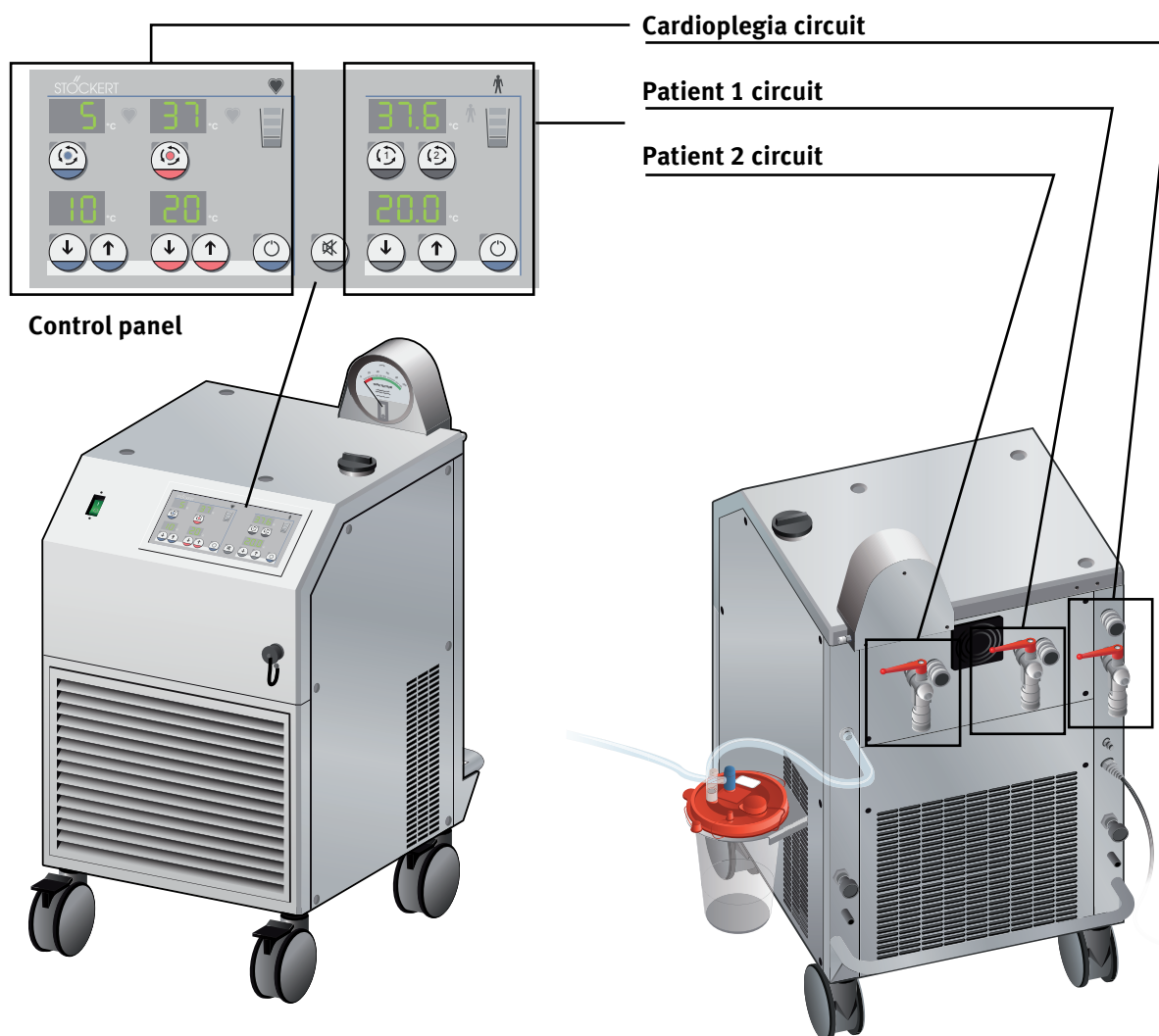

## 3.1.2 System components

Below are lists of standard components, mandatory components, and optional components that can be used with the heater-cooler. To obtain additional components, contact LivaNova Deutschland GmbH or your local LivaNova distributor.

### **Standard components (included in delivery)**

- Heater-Cooler System 3T
- Aerosol collection container holder
- 1/2" tubing connectors, straight (3 pieces)
- 1/2" tubing connectors, 90° angle (3 pieces)
- CAN cable for connection to the S5/C5 System
- Potential equalization cable
- Screwdriver for zeroing the vacuum gauge
- Operating instructions

### **Mandatory components (not included in delivery)**

- 3T Aerosol Collection Set

### **Optional components (not available from LivaNova)**

- Tubing sets and/or adapters for connecting single-use heating/cooling blankets
- Single-use heating/cooling blankets for adults (55 x 150 cm)

### 3.1.3 Explanation of the heater-cooler circuits and tanks

**The heater-cooler has three circuits: the cardioplegia circuit, the patient 1 circuit, and the patient 2 circuit.**

See chapter 3.2.2 for more details on the control panel which you will use to control each circuit.

#### The cardioplegia circuit uses two tanks

- There is one cardioplegia circuit, accessed from the inlet and outlet valves on the back of the heater-cooler.
- This circuit can be switched between either the heating tank or the cooling tank inside the heater-cooler. The heating and cooling tanks are separate so that water can be kept at desired temperatures even when not being accessed:

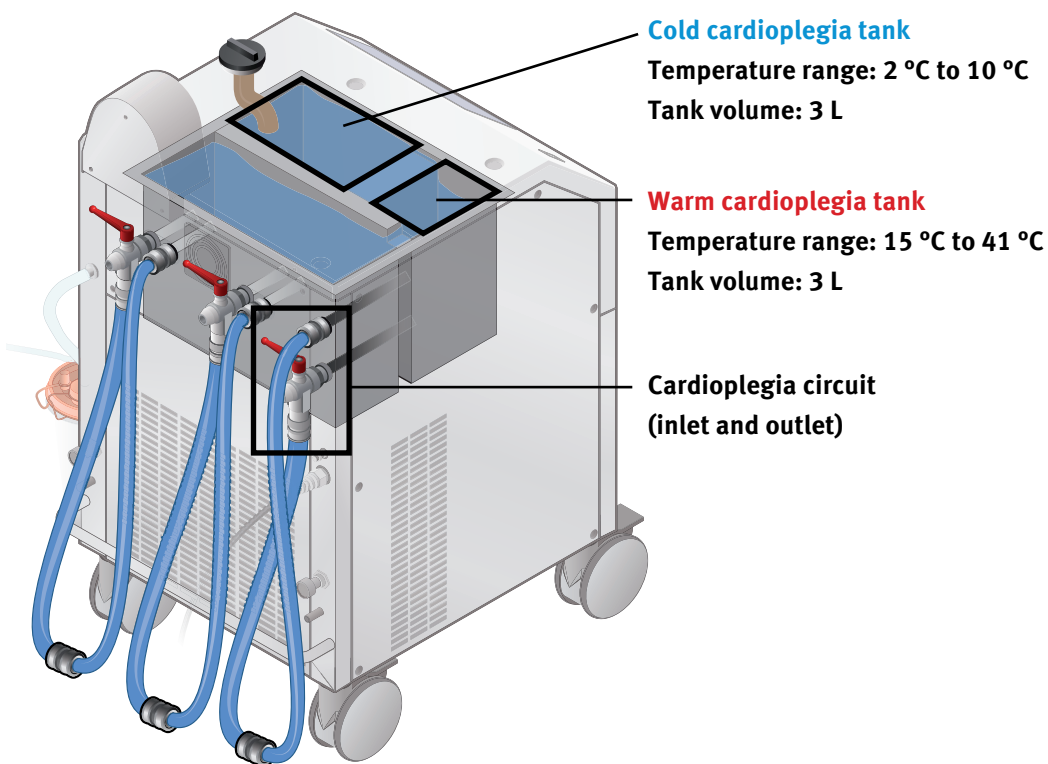

- The cardioplegia circuit can only be circulating from one of these tanks at a time. For example, if the warm cardioplegia pump is running and you power on the cold cardioplegia pump, the heater-cooler will circulate water from the cold cardioplegia tank and stop circulating water from the warm cardioplegia tank.

## The two patient circuits use one tank

- There are two patient circuits, accessed from the patient 1 and patient 2 inlet and outlet valves on the back of the heater-cooler. These circuits can be used with the oxygenator and/or the single-use heating/cooling blanket.
- The patient 1 and patient 2 circuits can be run at the same time or one at a time.
- Both patient circuits access the same tank (i.e., one tank) inside the heater-cooler. As such, both patient circuits will always be set to the same temperature.

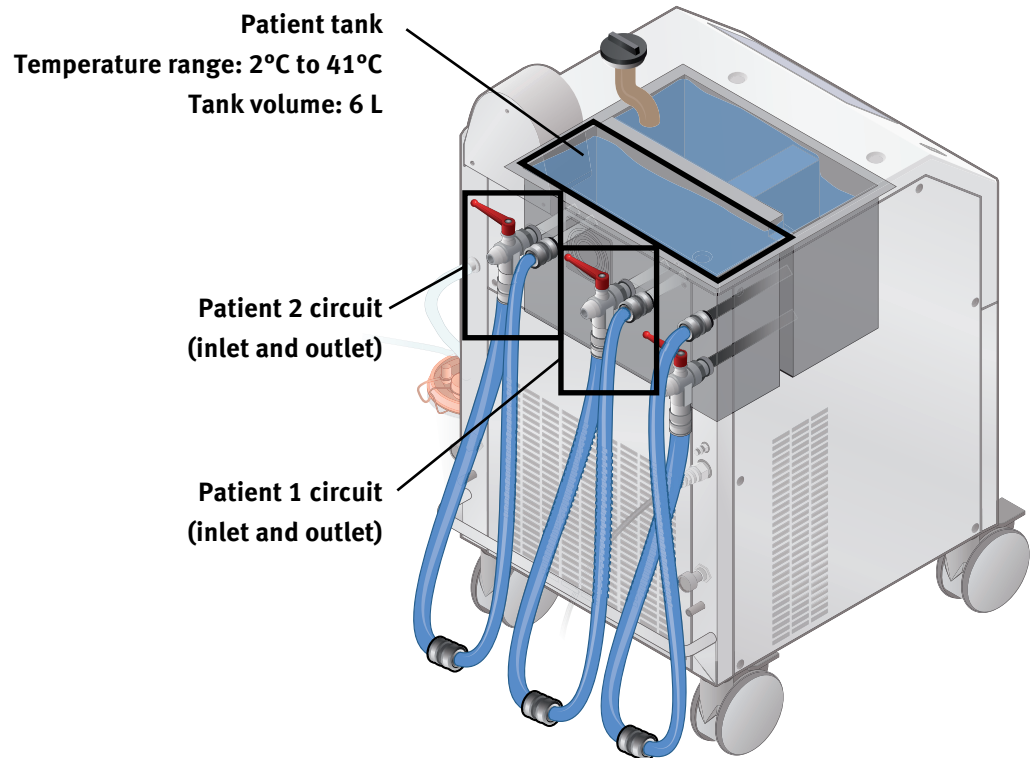

- The circuits for the patient and the circuit for cardioplegia can be switched off separately to increase the heating and cooling performance of active circuit(s). See chapter 5.6 for details.

## How the heater-cooler's three tanks fill

As you pour water into the single filler neck, all three tanks will fill in the following order:

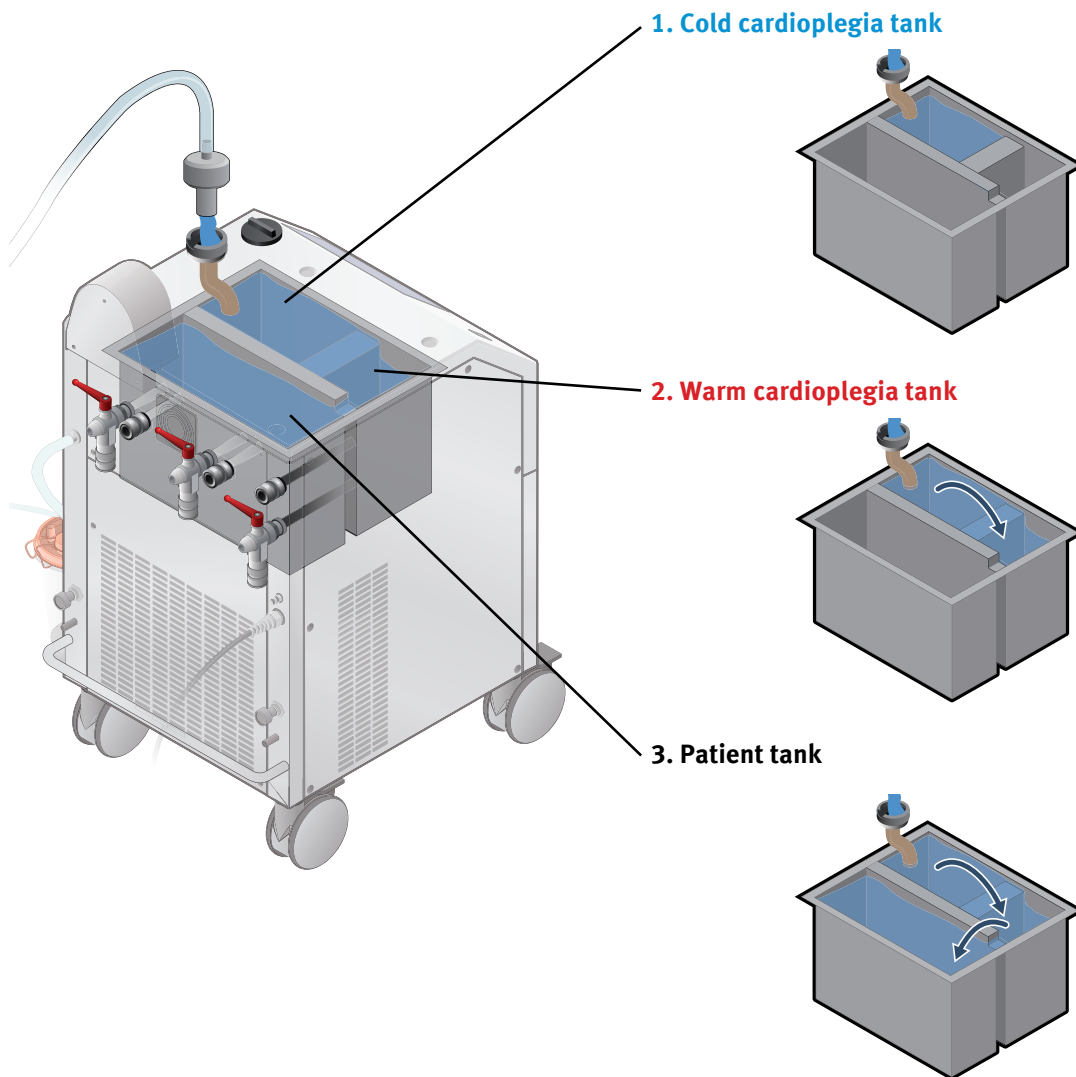

### Additional information about water tank levels:

- The cardioplegia tanks must fill completely before the patient tank begins to fill.
- After filling, and during operation, the system will equalize the water levels between the two cardioplegia tanks. Therefore, running one pump (i.e., the warm or cold pump) will reduce the water level in both tanks.



## 3.2 Structure of the heater-cooler

### 3.2.1 Heater-cooler overview

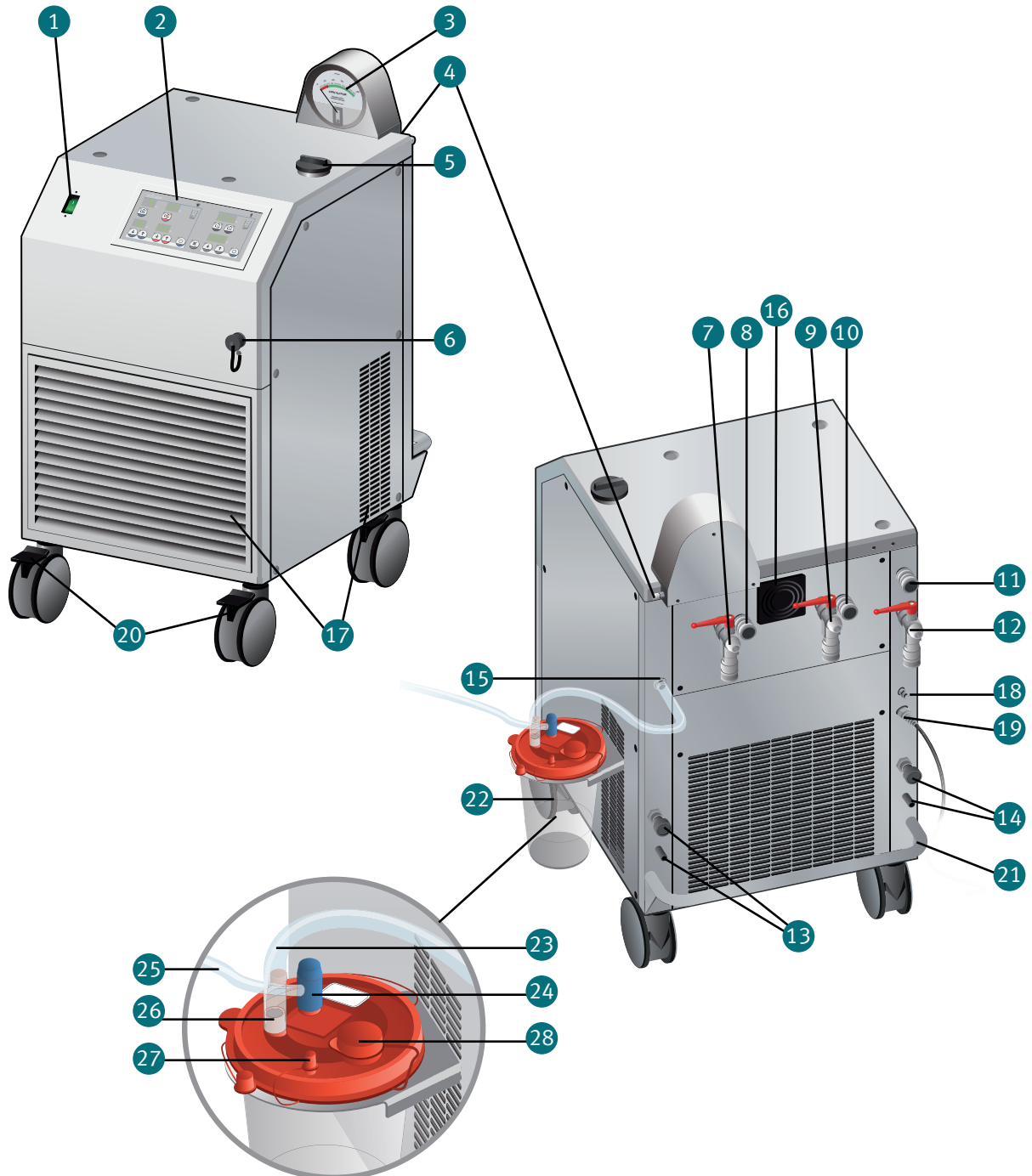

### Items depicted in heater-cooler overview

Item	Name	Function
1	Mains power switch	<ul style="list-style-type: none"> <li>For powering the heater-cooler on/off</li> <li>Integrated automatic circuit breaker</li> </ul>
2	Control panel	For separated operation and configuration of the three circuits <ul style="list-style-type: none"> <li>Two patient circuits</li> <li>One cardioplegia circuit</li> </ul>
3	Vacuum gauge with scale	Indicates the vacuum level inside the tanks
4	Vacuum gauge service port	For removing potential obstructions within the internal pressure monitoring line
5	Filler neck with cap	For filling all tanks with filtered tap water
6	CAN jack with cover	For connecting the heater-cooler to the S5/C5 System
7	Patient 2 circuit outlet connector with valve lever	For connecting the tubing, all inlets and outlets with 1/2" tubing connectors
8	Patient 2 circuit inlet connector	
9	Patient 1 circuit outlet connector with valve lever	
10	Patient 1 circuit inlet connector	
11	Cardioplegia circuit inlet connector	
12	Cardioplegia circuit outlet connector with valve lever	
13	Patient tank drain valve	For emptying the tanks
14	Cardioplegia tank drain valve	
15	Overflow outlet	For draining excessive water from the tanks and for connecting the aerosol collection container
16	Fan	For ventilation of the heater-cooler
17	Ventilation grill	
18	Potential equalization point	For connecting the potential equalization cable
19	Power cable	Power supply of the heater-cooler
20	Castors	Castors with brakes
21	Bumper	Protects the valves, drains, etc. against accidental crashes
22	Aerosol collection set (with tubing)	For collecting aerosol

### Items depicted in heater-cooler overview (continued)

Item	Name	Function
23	Connection line (short line)	For connecting the aerosol collection container to the heater-cooler
24	Vacuum port (V)	Connection point on the aerosol collection container for the vacuum source line
25	Vacuum source line (long line)	For connecting the aerosol collection container to the external vacuum source
26	Patient port (P)	Connection point on the aerosol collection container for the connection line
27	Tandem port (T)	Unused (capped at all times)
28	Pour spout (S)	Port for emptying the aerosol collection container (capped during normal use)

### 3.2.2 Heater-cooler control panel overview

The control panel manages all control and monitoring functions of the heater-cooler. Specifically, the control panel:

- Is used to adjust the temperature set values
- Is used to start and stop the circuit pumps
- Displays all set and actual temperatures
- Displays water level in the three tanks

The control panel is divided into two sections:

- ♥ Cardioplegia circuit controls, which include the warm tank and the cold tank.
- 👤 Patient 1 and patient 2 circuit controls, which includes one tank for the two patient circuits.

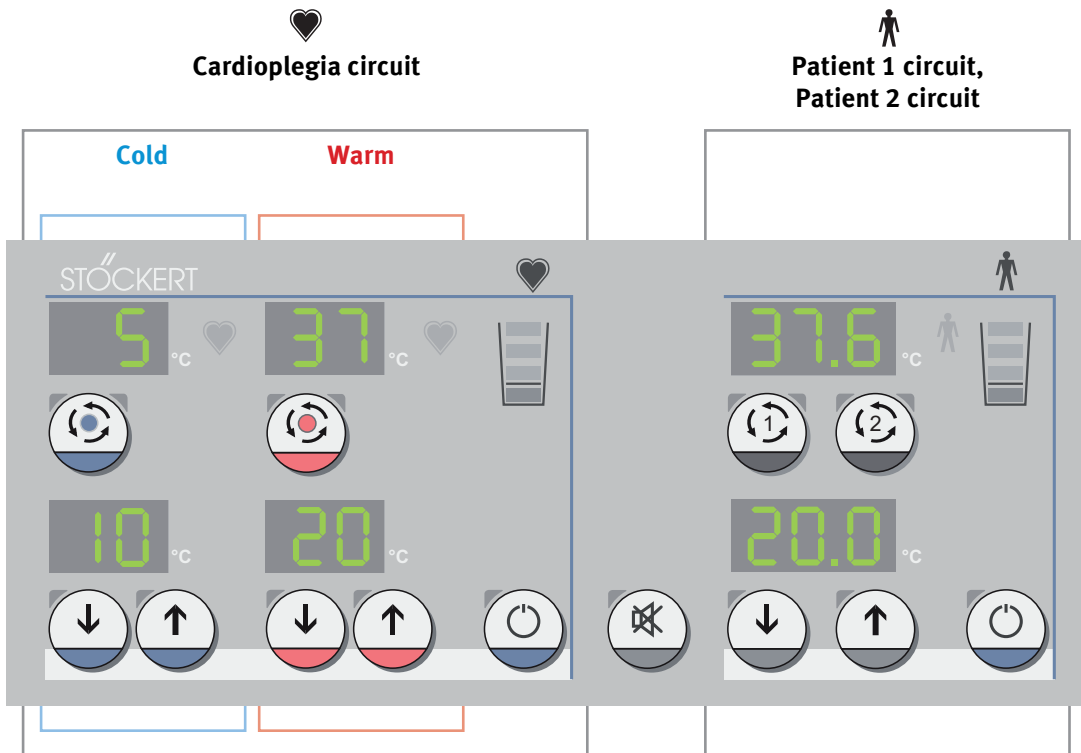

## ♥ Cardioplegia circuit controls

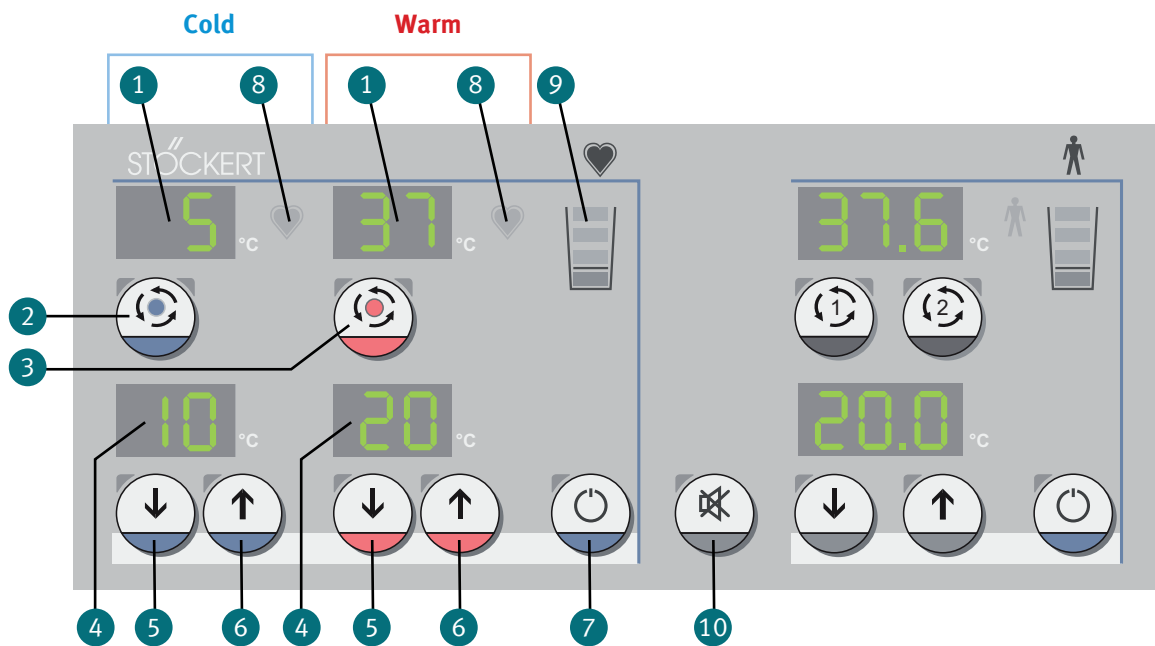

Item	Name	Function
1	Actual temperature display	Display the actual tank temperatures
2	Cold cardioplegia circuit Stop/Stop button	For starting and stopping the circuit and for switching from the warm to the cold tank
3	Warm cardioplegia circuit Stop/Stop button	For starting and stopping the circuit and for switching from the cold to warm tank
4	Set temperature display	Displays the tank set temperatures
5	Set value down button	For decreasing the set temperature
6	Set value up button	For increasing the set temperature
7	Standby button	For switching the cardioplegia circuit on and off
8	High temperature indicator	Illuminates red if high tank temperature detected
9	Water level display	Displays the water level in the tanks
10	Pause audio button (global control)	Pauses the audible tone for a maximum of 2 minutes. Pressing the button again switches the audible tone back on.



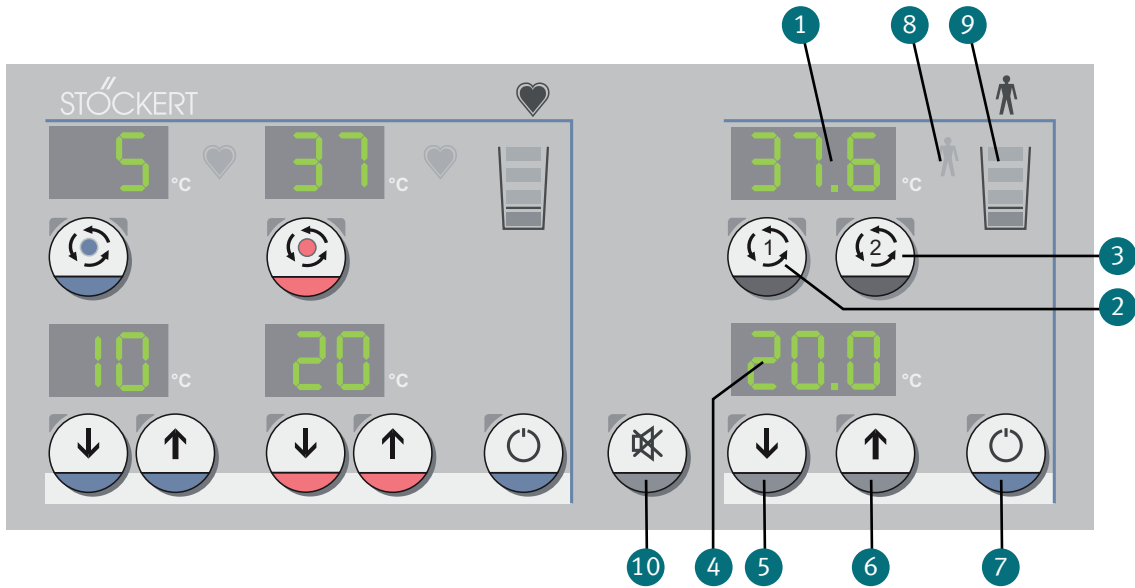

## Patient 1 and patient 2 circuit controls

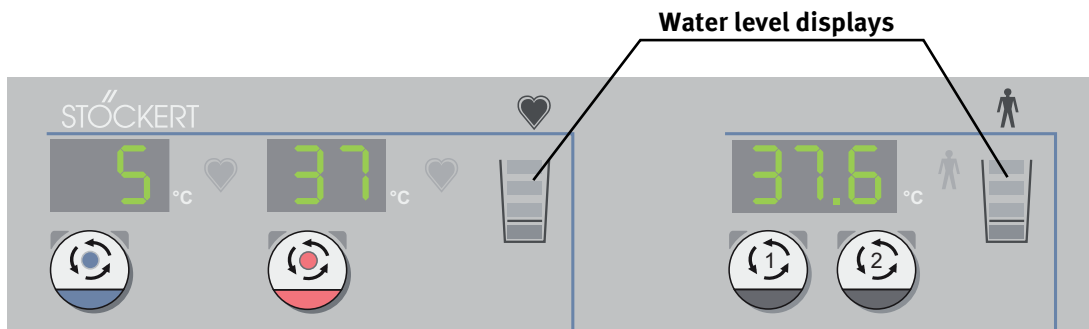

Item	Name	Function
1	Actual temperature display	Display the actual tank temperatures
2	Patient 1 circuit Start/Stop button	For starting and stopping the patient 1 circuit
3	Patient 2 circuit Start/Stop button	For starting and stopping the patient 2 circuit
4	Set temperature display	Displays the set temperatures
5	Set value down button	For decreasing the set temperature
6	Set value up button	For increasing the set temperature
7	Standby button	For switching the patient 1 and patient 2 circuits on and off.
8	High temperature indicator	Illuminates red if high tank temperature detected
9	Water level display	Displays the water level in the tanks
10	Pause audio button (global control)	Pauses the audible tone for a maximum of 2 minutes. Pressing the button again switches the audible tone back on.

## Explanation of the water level display



Display	Segment color	Water level meaning
	Second green	Maximum capacity
	First green	Full
	Orange	Solid: Low level Blinking: Low level warning. Refill recommended.
	Red	Must be refilled. Pump(s) and heating/cooling functions stop until refilled. <b>Circuit will not operate.</b>

## Explanation of special Set value button operations

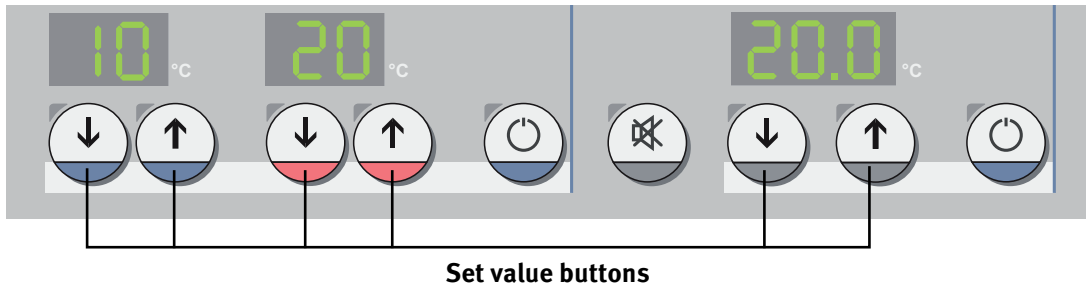

- For the cardioplegia Set values, pressing and holding a Set value button changes the temperature value by 1°C. Continuing to hold the Set value button will increase or decrease the set value more rapidly.
- For the patient set value, pressing and holding a Set value button initially changes the temperature value by 0.1 °C, then changes the temperature value by 1 °C. If you then release the Set value button and immediately press it once, the temperature value will still change by 1 °C.
- You can increase the temperature value change increment by pressing and holding one Set value button and pressing its counterpart (i.e., up or down) once.

### 3.2.3 Control panel S5/C5 System

The CAN port allows the heater-cooler to be connected to an S5 or C5 HLM. Operating the heater-cooler with the S5/C5 System does not require additional remote control modules. You do not need to make additional connections or perform additional steps besides connecting the CAN cable between the heater-cooler and the S5/C5 System.

You may control the heater-cooler with the S5/C5 System menu or directly on the base unit of the heater-cooler.

**NOTE:** Do not connect the heater cooler's CAN port to any other device. The heater-cooler is only compatible with the S5/C5 System.

Refer to the S5/C5 System's operating instructions for information about the heater-cooler's displays when in use with the S5/C5 System.



#### **Important**

The length of water circuit tubing between the heater-cooler and accessory devices **must not exceed 5 m**.



# 4 Preparing the heater-cooler for a procedure

**Read the following chapter thoroughly before operating the heater-cooler for the first time.**

This chapter provides instructions for preparing the heater-cooler for use.

See chapter 5 for detailed instructions for positioning and using the heater-cooler during a procedure.

See chapter 6 for detailed instructions for conducting scheduled maintenance activities.

## 4.1 General technical requirements

### 4.1.1 General use requirements

- Operate the heater-cooler only at ambient temperatures between 10 °C and 30 °C.
- Operate the heater-cooler in a spacious area. The heater-cooler can overheat if operated in a confined space. Maintain a separation of at least 70 cm between the ventilation grills and walls or other devices.
- Do not position the heater-cooler where it will block access to the mains power plug. Removing the mains plug from the receptacle isolates the machine from mains voltage and the plug must remain accessible at all times.
- The heater-cooler must be connected to a potential equalization point for the safety of operators and patients.
- Electrical installations must abide by the requirements stated in IEC 60364-7-710, or the corresponding equivalent local regulations.
- A central hospital vacuum source or a portable vacuum source must be available for operating the 3T Aerosol Collection Set.
  - Operate the heater-cooler with an applied vacuum source. Aerosol will not be collected from the water tanks without a vacuum source.
  - The vacuum source must be capable of a flow of 20 LPM or greater (ISO 10079-1 for Medical Suction Equipment).
  - Portable vacuum sources must be specified for medical applications and meet the requirements of IEC 60601-1 and IEC 60601-1-2.
  - The power supply for the vacuum source must be connected to a back-up power generator to avoid power loss during use.

## 4.1.2 Materials you will need (not provided with the heater-cooler)

- Tubing sets compatible for connecting:
  - the oxygenator
  - the cardioplegia heat exchanger
  - a single-use heating/cooling blanket, if used
- 3T Aerosol Collection Set (part number 050900100)



### **Important**

LivaNova recommends always having a replacement heater-cooler available in case the heater-cooler in use is no longer functional (e.g., due to a total system failure). The replacement heater-cooler must have compatible connectors.

## 4.2 Conducting any required disinfection and maintenance

### 1

#### Before first-time use of the heater-cooler

Complete the following procedures per the maintenance schedule in chapter 6.2.1 “Schedule: Disinfection and maintenance”:

- ✓ Disinfect the external surfaces
- ✓ Disinfect the water circuits

### 2

#### Before each use of the heater-cooler, verify that device maintenance is up to date

Verify that, if necessary, the following maintenance procedures have been completed per the maintenance schedule in chapter 6.2.1 “Schedule: Disinfection and maintenance”:

- ✓ Disinfect the external surfaces
- ✓ Monitor the hydrogen peroxide concentration
- ✓ Replace the aerosol collection set
- ✓ Change the water and add hydrogen peroxide
- ✓ Disinfect the water circuits
- ✓ Monitor the water quality for total bacteria count
- ✓ Monitor the water quality for NTM
- ✓ Replace the tubings used with the heater-cooler

## 4.3 Connecting the procedural tubing



### Important

- Follow your hospital's policies regarding the use of personal protective equipment (PPE).
- Before connecting any tubings to the heater-cooler:
  - Disinfect all heater-cooler connectors, tubing fittings, and tubing connectors.
  - Disinfect all connectors and fittings on the tubings as well as the connectors for the water circuits.
- Do not use self-closing connectors. They will reduce water flow.
- Check all tubings, connectors, and accessories to ensure all water connections are properly sealed. Replace damaged components immediately.
- Check that all tubings are free of bends and kinks.
- Close inactive circuits with short-circuit tubing.

# 1

## Connect tubing to the water circuits

- ▣ 1 Before connecting any tubing to the heater-cooler, disinfect the following items:

- all heater-cooler connectors
- all tubing fittings and connectors



### Important

Disinfect connectors and fittings every time you make a connection according to chapter 6.3.2 and chapter 6.3.3.

Continue step on next page



- ▣ 2 Connect the procedural tubing to the circuit inlet and outlet ports:
- Push and hold the quick release ring back.
  - Insert the tubing fitting into the quick release ring.
  - Release the quick release ring which will click back into place and lock the tubing.

**Circuit inlet and outlet ports**

**Quick release ring**

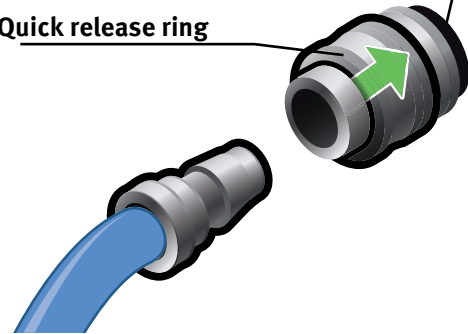

**Insert tubing fitting**

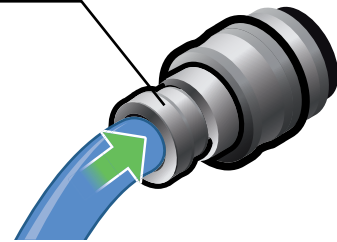

**Release to lock**

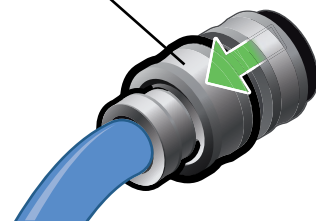

- ▣ 3 Check that the connection is secure by gently pulling on the tubing fitting.

**Gentle tug**



## 4.4 Connecting the potential equalization cable and the power supply

### Summary of steps you will complete in this section

1 Connect the potential equalization cable

2 Connect the power cable

### 1 Connect the potential equalization cable

- ▣ 1 Connect the potential equalization cable to the heater-cooler's potential equalization point.
- ▣ 2 Connect the potential equalization cable's other end to the potential equalization point at the OR's central ground.

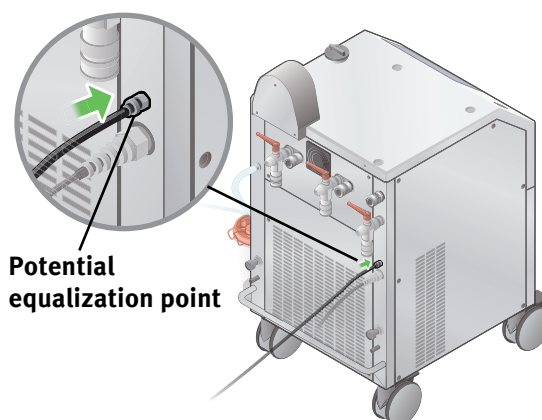



## 2

### Connect the power cable

- 1 Connect the AC power cable to an appropriate outlet.

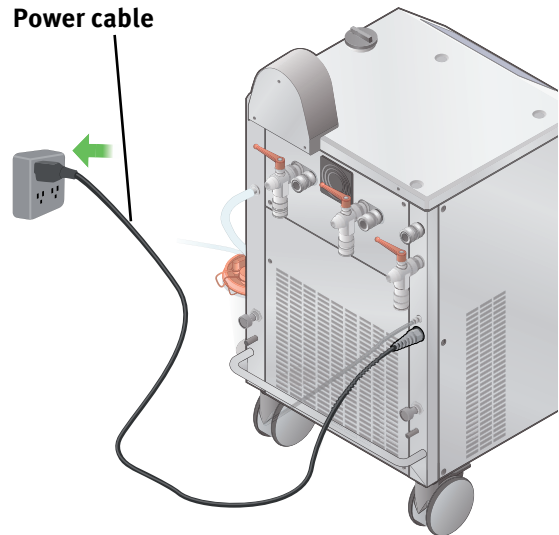

#### WARNING

Do not connect the heater-cooler to a heart-lung machine's auxiliary outlet. The heater-cooler should be connected to a separate dedicated AC line.

To avoid the risk of electric shock, the heater-cooler must only be connected to a supply mains with protective earth.

## 4.5 Connecting the aerosol collection set



### WARNING

Operation of the heater-cooler without an applied vacuum source will stop the collection of aerosol from the water tanks.

### Summary of steps you will complete in this section

- 1 **Dispose of the aerosol collection set after 7 days**
- 2 **Prepare the heater-cooler**
- 3 **Prepare the aerosol collection canister**
- 4 **Connect the aerosol collection set to the heater-cooler**

# 1

## Dispose of the aerosol collection set after 7 days

If an aerosol collection set is already attached to the heater-cooler (e.g., from a previous procedure), check the installation date written on the aerosol collection canister lid:

- If the aerosol collection set is more than 7 days old, bring the aerosol collection set to the disposal area, and dispose of in accordance with your hospital's policies. Be sure to dispose of all components:
  - Canister
  - Canister lid
  - Heater-cooler connection line
  - Vacuum source line
  - Vacuum source extension line (if applicable)
- If the aerosol collection set is less than 7 days old, you may empty the canister according to chapter 5.7.2 and reconnect the emptied canister following the applicable steps in this chapter. Or, you may replace the entire aerosol collection set.

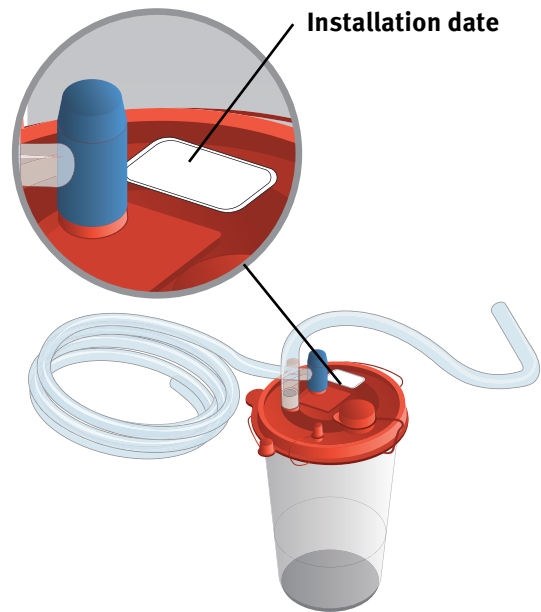

## 2

### Prepare the heater-cooler

- 1 Make sure that the heater-cooler is powered off.

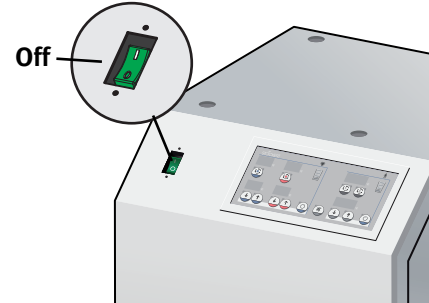

- 2 Verify that the vacuum gauge reads 0 Pa.

If the vacuum gauge does not read 0 Pa, use the provided screwdriver to turn the adjustment screw near the bottom of the gauge. Turn the adjustment screw until the indicator needle is set to 0 Pa.

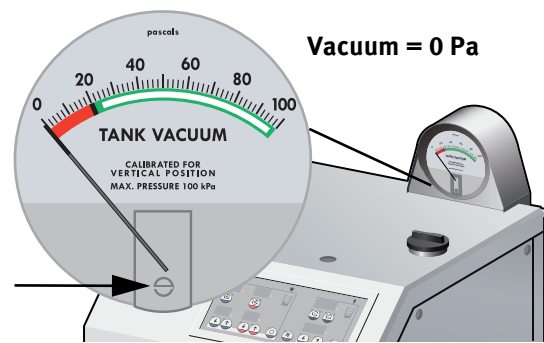

- 3 Attach the aerosol collection canister holder to the heater-cooler by inserting the two top tabs of the holder into the vent slots on the heater-cooler. Release the holder and allow it to rest in a horizontal position.

**NOTE:** Make sure that the holder is positioned such that the aerosol collection canister does not touch the floor or any part of the heater-cooler.

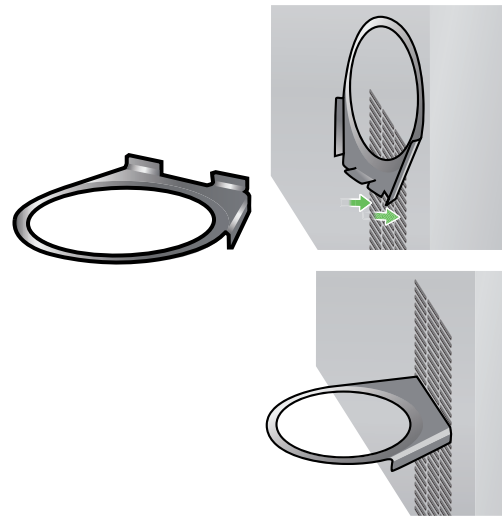

### 3 Prepare the aerosol collection canister

- ▣ 1 Gather a new aerosol collection set, and remove the components from the packaging:
  - Aerosol collection canister
  - Canister lid
  - Vacuum source line (with right-angle connector)
  - Heater-cooler connection line

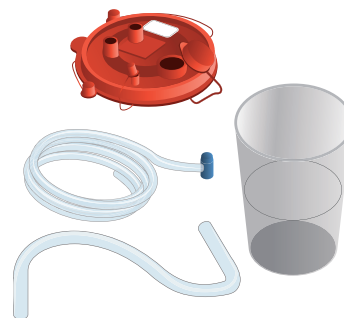

#### CAUTION

**Prior to use**, visually inspect the 3T Aerosol Collection Set to ensure that connections, seals, and components were not damaged during shipment. Do not use the 3T Aerosol Collection Set if any defects are found.

- ▣ 2 Place the lid on the aerosol collection canister, and secure the lid around the entire perimeter.

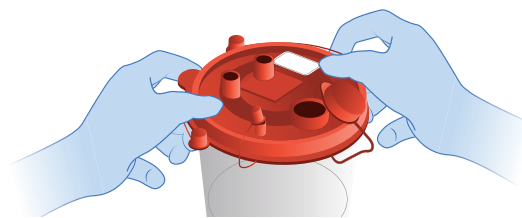

- ▣ 3 Apply the following caps over their respective openings:
  - Pour spout
  - Tandem port

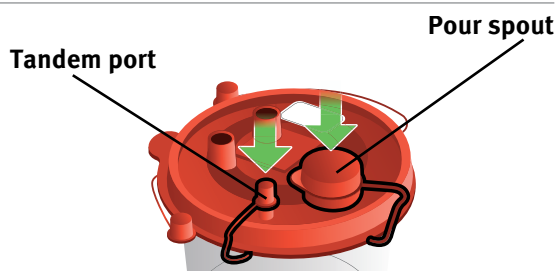

- ▣ 4 Place the aerosol collection canister into the holder.

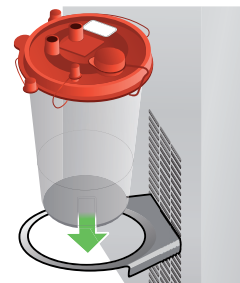

## 4

### Connect the aerosol collection set to the heater-cooler

- 1 Connect the heater-cooler connection line (the short line) to the heater-cooler overflow outlet.

Heater-cooler overflow outlet

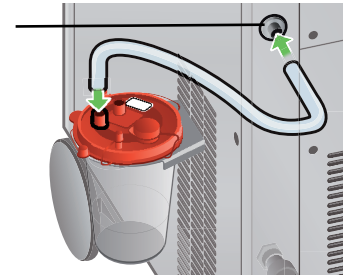

#### CAUTION

Do not connect the heater-cooler connection line to the vacuum service port or the drain valve. This will limit the vacuum flow to the aerosol collection canister.

- 2 Connect the other end of the heater-cooler connection line (the short line) to aerosol collection canister lid's PATIENT port (P).

Heater-cooler connection line

PATIENT port (P)

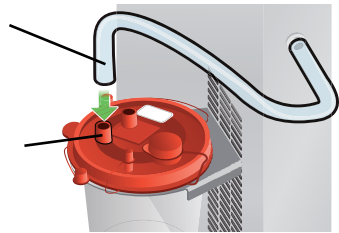

#### Important

Pushing the connection line too far onto port will make the line very difficult to remove later.

- 3 Connect the vacuum source line's (the long line) right angle connector to the aerosol collection canister lid's VACUUM port (V).
- 4 Check that the vacuum source line is free of kinks.

Right angle connector

Vacuum source line

VACUUM port (V)

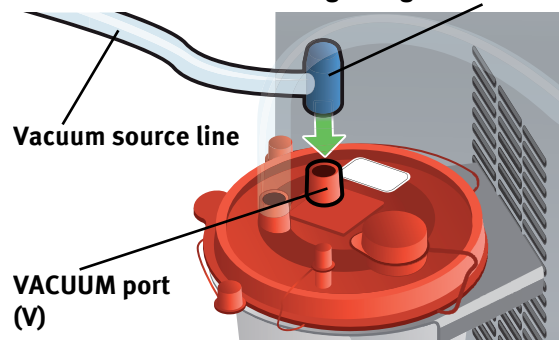

Continue step on next page ▶

- ▣ 5 Connect the vacuum source line's (the long line) other end to the external vacuum source.

**NOTE:** LivaNova recommends connecting an overflow safety trap to the external vacuum source. This will avoid liquid introduction into the external vacuum source's system.

**NOTE:** If additional length is needed to access the external vacuum source, attach a vacuum extension line to the vacuum source line. Order this part separately (part number 050900111).

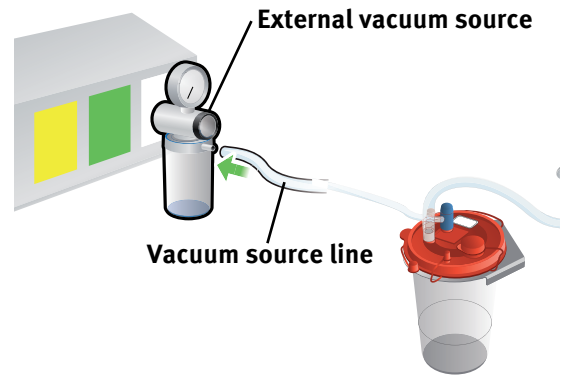

#### CAUTION

You must connect the vacuum source line to a vacuum regulator. This will control and adjust the flow to the aerosol collection canister.

Continue step on next page



- ☑ 6 Check that all lid caps and connections are secure:
  - ✓ Vacuum source line (a)
  - ✓ Heater-cooler connection line (b)
  - ✓ Tandem port cap (c)
  - ✓ Pour spout cap (d)
  - ✓ Vacuum source extension line (if applicable)

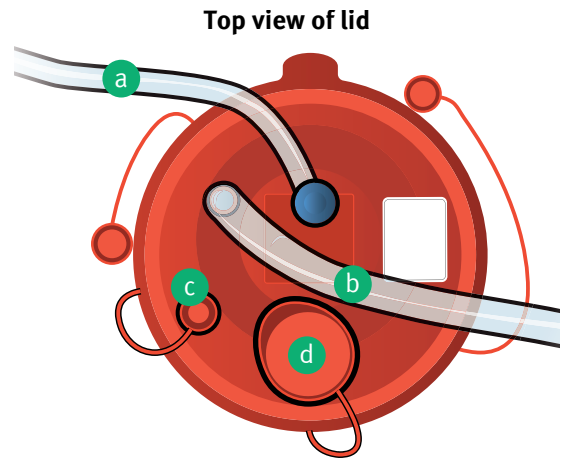

- ☑ 7 Write the date of installation on the lid's label.
- ☑ 8 The aerosol collection set is now ready for use.

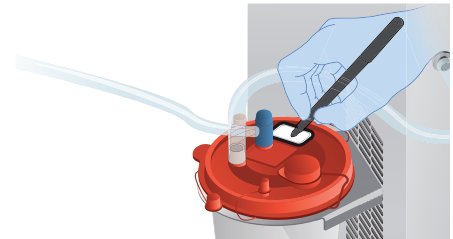



## 4.6 Connecting to the S5/C5 System (if applicable)

**1**

### **Connect the heater-cooler to the S5/C5 System**

Connect the heater-cooler to the S5/C5 System according to the separate S5/C5 System's operating instructions.

## 4.7 Filling and mixing water tanks



### Important

- Follow your hospital's policies regarding the use of personal protective equipment (PPE).
- Do not use de-ionized or reverse osmosis processed water. These types of water can cause deterioration of the refrigeration system.

### Summary of steps you will complete in this section

- 1 Prepare for filling
- 2 Fill the water tanks
- 3 Prepare for mixing
- 4 Mix the tank contents

## 1 Prepare for filling

- ▣ 1 Make sure that you have access to filtered tap water that has been filtered using the following filter and specifications:



### Important

Disposable Pall-Aquasafe water filter with an 0.2 µm membrane (Pall part reference in the U.S.: “AQINA”; “AQIN” in other countries) or a filter of equivalent performance that meets the requirements for bacterial retention of *Brevundimonas diminuta* to  $\geq 10^7$  CFU/cm<sup>2</sup> of effective filtration area.\*

(\*American Standard Test Method F838-15ae1 “Determining Bacterial Retention of Membrane Filters Utilized for Liquid Filtration”)

- ▣ 2 Gather the following materials:
  - 150 mL of medical grade 3% hydrogen peroxide solution
  - Measuring cup
- ▣ 3 Check to ensure that hydrogen peroxide solution is not expired.

- ▣ 4 If the water tanks have been drained (i.e., are empty), the red segment on both water level displays will be illuminated.

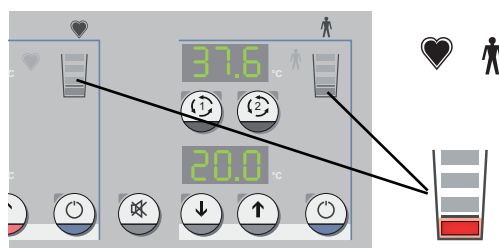

**NOTE:** Confirm that the water level displays function correctly after performing a water change or disinfection.

- ▣ 5 Make sure that the aerosol collection canister is empty. Refer to chapter 5.7.2 for instructions on emptying the aerosol collection canister.

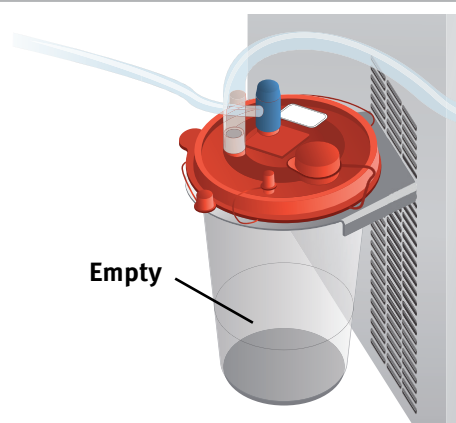

Continue step on next page ▶

- ▣ 6 Make sure that both drain valves are fully closed so that water does not flow out when filling the water tanks.

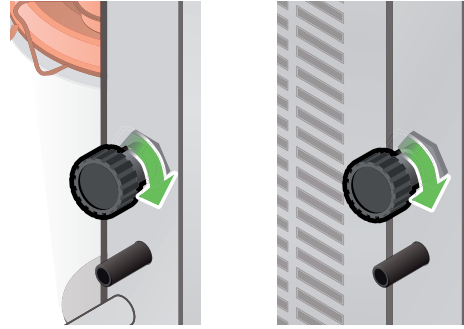

- ▣ 7 Press the mains power switch to power on the heater-cooler.

**NOTE:** A tone will sound indicating that the heater-cooler tanks are empty. You can press the Pause Audio button to pause the tone.

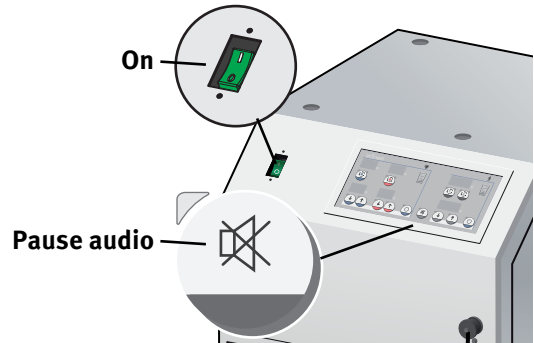

- ▣ 8 Turn the filler neck cap counterclockwise to remove.

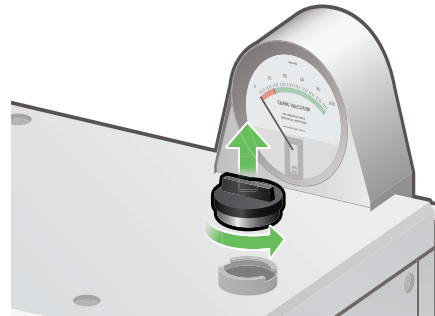

- ▣ 9 Apply four sprays of disinfectant on the cap until all surfaces are wet, including the cap's underside and sealing surface.

- ▣ 10 Wait for 5 minutes. Ensure that all surfaces remain wet with disinfectant during this time. Apply additional disinfectant if necessary.

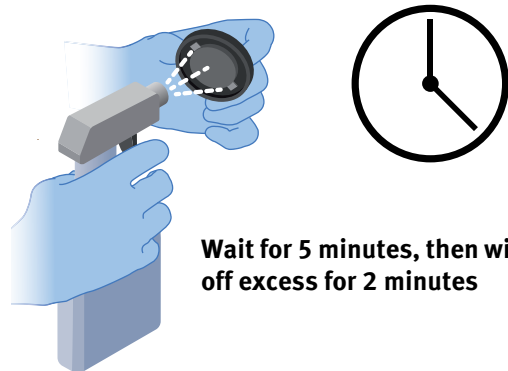

**Wait for 5 minutes, then wipe off excess for 2 minutes**

Wipe all surfaces with a disinfectant wipe for 2 minutes to remove excess disinfectant.

## 2

### Fill the water tanks



#### Important

As you pour water into the single filler neck, all three tanks will fill in the following order:

- Cold cardioplegia tank
- Warm cardioplegia tank
- Patient tank

#### If the water tanks are not empty:

- Prepare a mixture of hydrogen peroxide and filtered tap water at a ratio of 1:91. For example: 10 mL of hydrogen peroxide and 910 mL of filtered tap water
- Fill the water tanks with the mixture until the **second green segments** of both circuit water level displays light up.
- Continue to step 3, *Prepare for mixing*.

#### 1:91 mixture hydrogen peroxide to filtered tap water

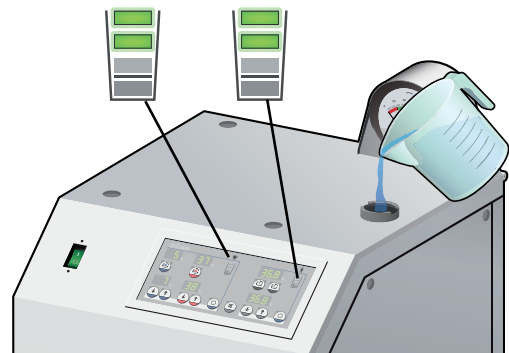

#### If the water tanks are empty, complete the rest of step 2:

- ☑ 1 Begin filling the water tanks with filtered tap water.

**NOTE:** The use of any other liquid is not recommended.

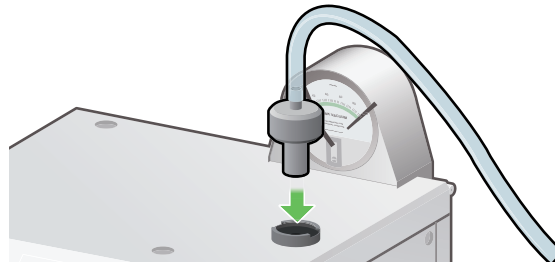

Continue step on next page ▶

- ▣ 2 Pause filling when the **orange segment** on the **patient circuit** water level display lights up.

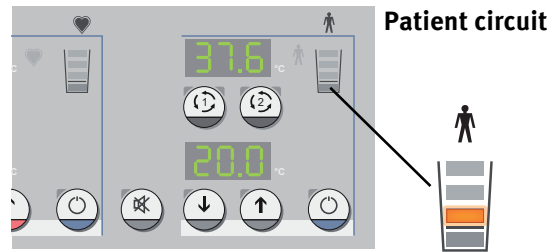

- ▣ 3 Pour 150 mL of medical grade 3% hydrogen peroxide solution into the tank.

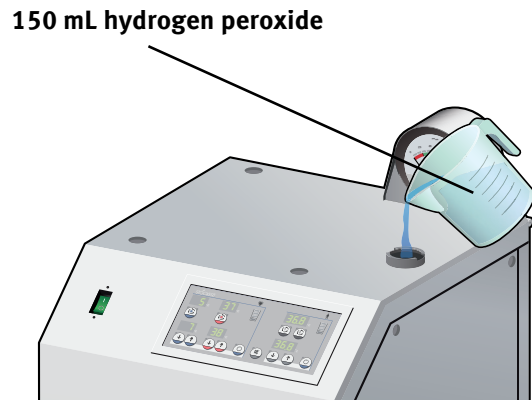

- ▣ 4 Continue filling the tanks with filtered tap water until the **second green segment** of the **patient circuit** water level display lights up.

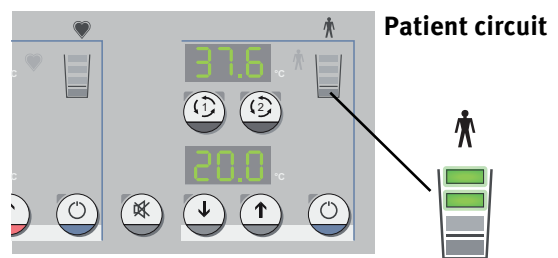

- ▣ 5 Attach the filler neck cap, and turn clockwise to secure.

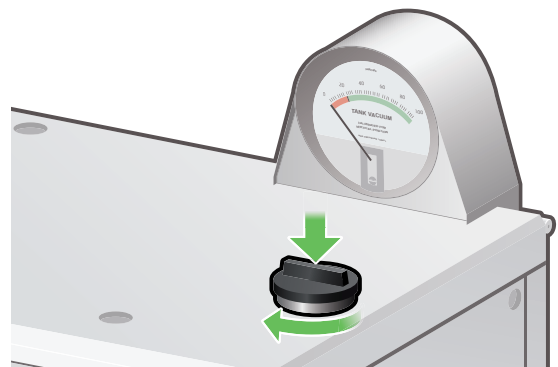

### 3 Prepare for mixing

- ▣ 1 On the back of the heater-cooler, make sure that the three red valve levers are closed. Turn clockwise to close.
- ▣ 2 Disinfect the heater-cooler connectors and short-circuit tubing fittings.

Close all valves

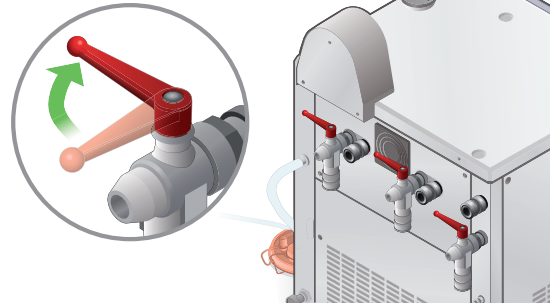

#### Important

Disinfect connectors and fittings every time you make a connection according to chapter 6.3.2 and chapter 6.3.3.

- ▣ 3 Connect short-circuit tubing between the cardioplegia circuit inlet and the patient 1 circuit inlet.

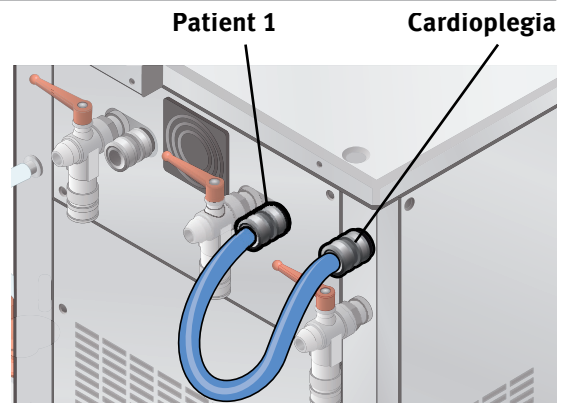

- ▣ 4 To avoid triggering a high temperature warning while mixing:

Set the **cold cardioplegia** circuit to 10 °C.

Set the **warm cardioplegia** circuit to 20 °C.

Set the patient circuit to 20.0 °C.

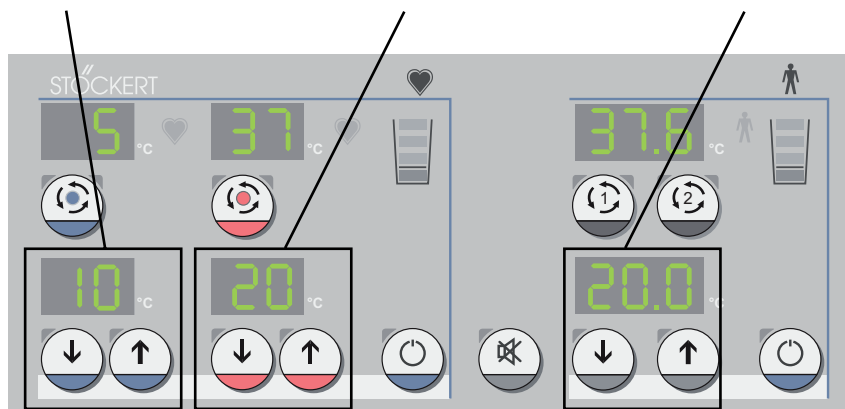

## 4 Mix the tank contents

- 1 Press the **cold cardioplegia** circuit Start/Stop button to start mixing.

**NOTE:** The green LEDs will flash alternately to indicate the circuit is running.

Press **cold cardioplegia** to start

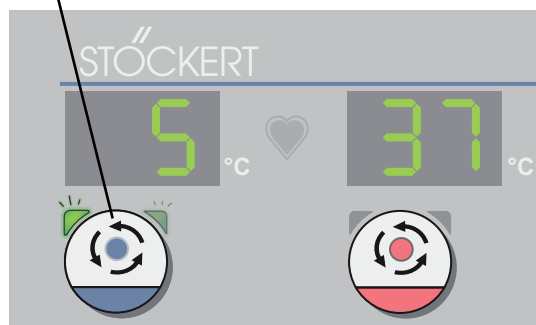

### CAUTION

Operate **ONLY** the **cold cardioplegia** circuit to ensure proper mixing.

- 2 After 5 minutes, press the **cold cardioplegia** circuit Start/Stop button again to stop mixing.

The mixing process is now complete.

After 5 minutes, press to stop

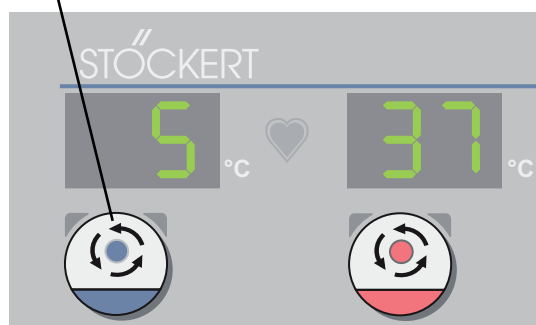

- 3 Disconnect the short-circuit tubing.

Tank filling is now complete.

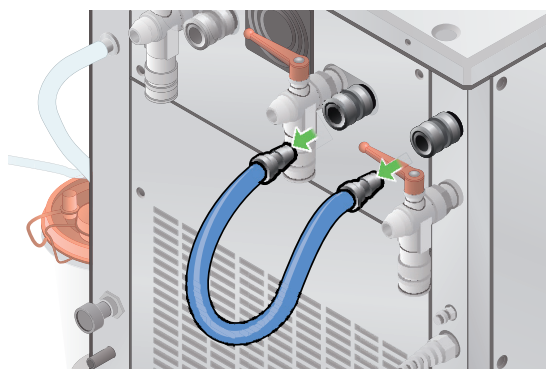



# 5 Using the heater-cooler during a procedure

**Read the following chapter thoroughly before operating the heater-cooler for the first time.**

This chapter provides instructions for positioning the heater-cooler in the OR and using the heater-cooler's controls during a procedure.

See chapter 4 for detailed instructions for preparing the heater-cooler for use.

This chapter also provides the basic steps you will conduct after a procedure.

See chapter 6 for detailed instructions for conducting scheduled maintenance activities.

## 5.1 Positioning the heater-cooler in the OR



### Important

- Do not cover the ventilation grills.
- Maintain at least 70 cm clearance from walls and other devices to prevent the heater-cooler from overheating.
- The length of water circuit tubing between the heater-cooler and accessory devices must not exceed 5 m.

### Summary of steps you will complete in this section

- 1 Bring the heater-cooler into the OR
- 2 Place the heater-cooler in a safe position
- 3 Connect a portable vacuum source, if needed

## 1

### Bring the heater-cooler into the OR

- ▣ 1 If the heater-cooler is not already in the OR, bring the heater-cooler to the OR.
- ▣ 2 Place the heater-cooler on a level, even floor.

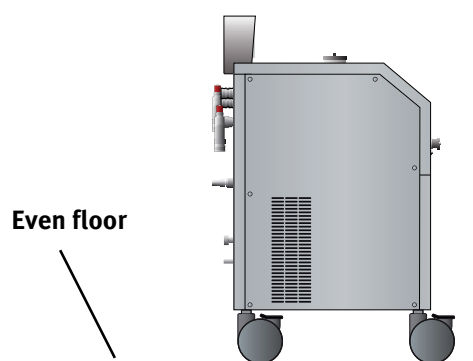

## 2

### Place the heater-cooler in a safe position

- 1 Place the heater-cooler at a sufficient distance (at least 70 cm) from walls and other devices.

Make sure that the ventilation grills are not covered.

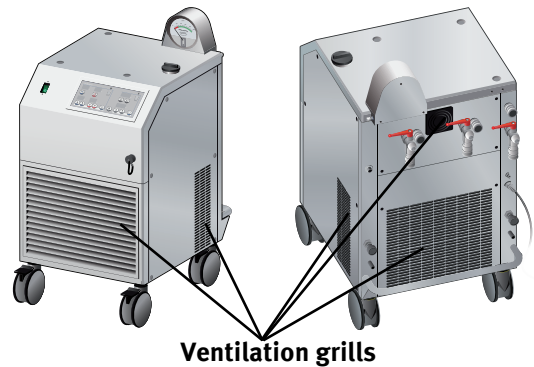

- 2 Position the heater-cooler's and portable vacuum source's (if applicable) exhaust flow away from the operating field and toward the exhaust vent system.

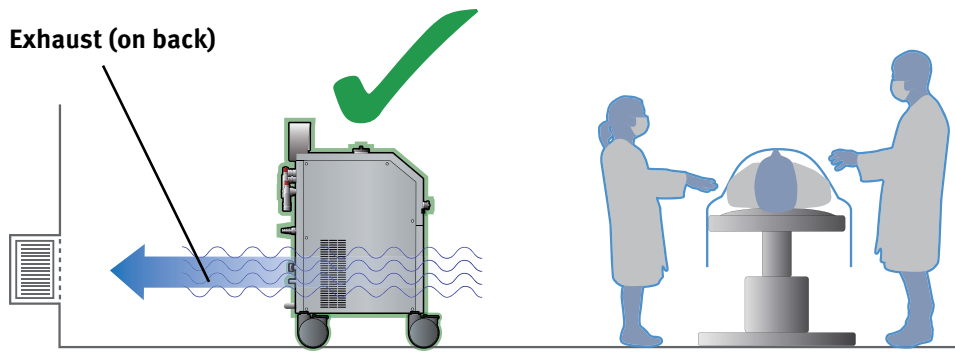

#### WARNING

**Do not** position the heater-cooler's and portable vacuum source's (if applicable) exhaust flow toward the operating field. Position the exhaust flow away from the operating field and toward the exhaust vent system.

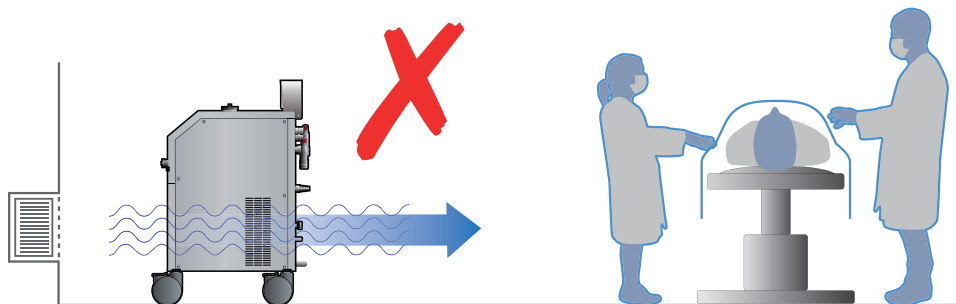

Continue step on next page ▶

- ▣ 3 Step down on the brakes and lock the castors.

Lock brakes

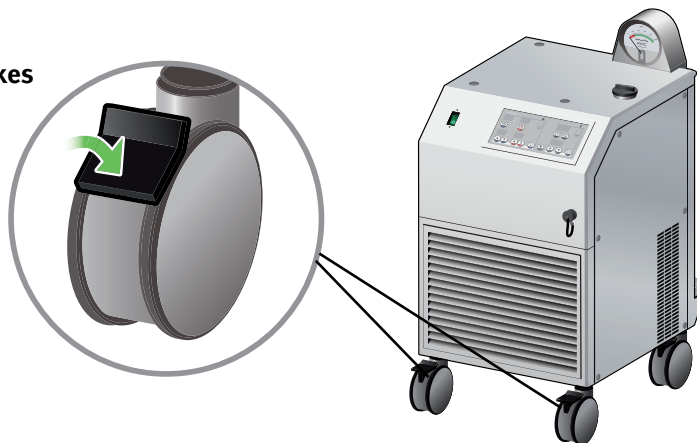

### 3

#### Connect a portable vacuum source, if needed

- ▣ If you are using a portable vacuum source, mount and operate the device according to its instructions for use. Pay special attention to the instructions related to use of the vacuum source in the OR.

## 5.2 Connecting the procedural tubing to external devices

### Summary of steps you will complete in this section

- 1 Connect the procedural tubing to the external devices
- 2 Check the procedural tubing and connections to all devices

### 1 Connect the procedural tubing to the external devices

- ▣ 1 Before making any connections, disinfect the connectors on the procedural tubing.

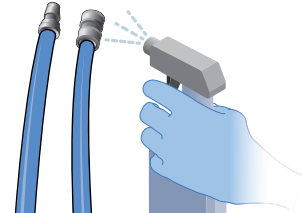

#### Important

- Disinfect the connectors and fittings every time you make a connection according to chapter 6.3.2 and chapter 6.3.3.
- **Do not** apply disinfectant to the fittings on the external devices.

- ▣ 2 Connect the procedural tubing to the external devices.

### 2

### Check the procedural tubing and connections to all devices

- ▣ Inspect the heater-cooler procedural tubing and make sure:
- Tubing is free of kinks
  - Tubing is not damaged
  - Connections to devices in the OR are secure

## Overview of a typical circuit

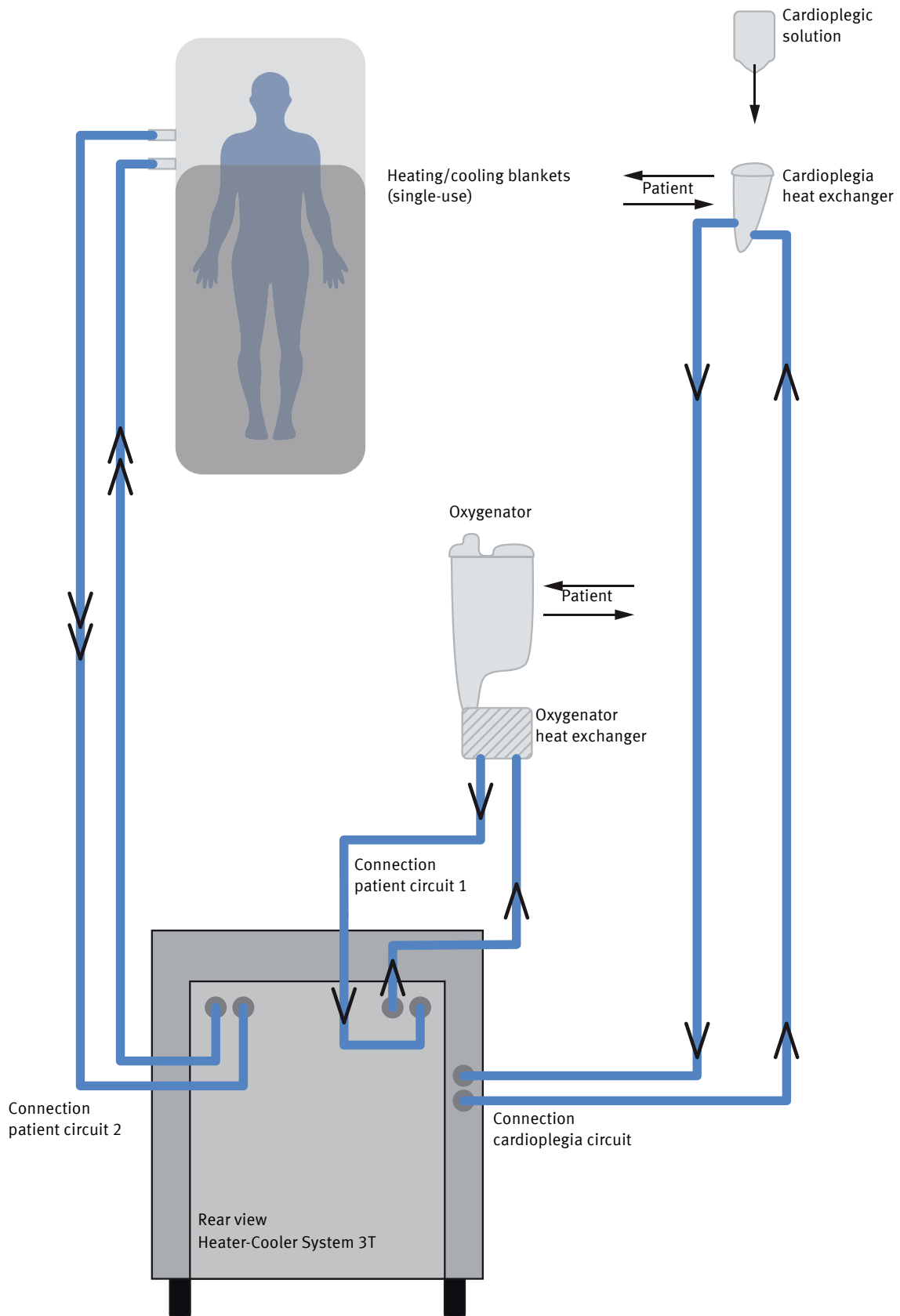

## 5.3 Powering on and checking the panel



### WARNING

Operation of the heater-cooler without an applied vacuum source will stop the collection of aerosol from the water tanks.

### Summary of steps you will complete in this section

- 1 Connect the vacuum source
- 2 Power on the heater-cooler and observe the self-test
- 3 Check the control panel to confirm the heater-cooler is ready for use

## 1

### Connect the vacuum source

- 1 Verify that the vacuum gauge reads 0 Pa.

If the vacuum gauge does not read 0 Pa, use the provided screwdriver to turn the adjustment screw near the bottom of the gauge. Turn the adjustment screw until the indicator needle is set to 0 Pa.

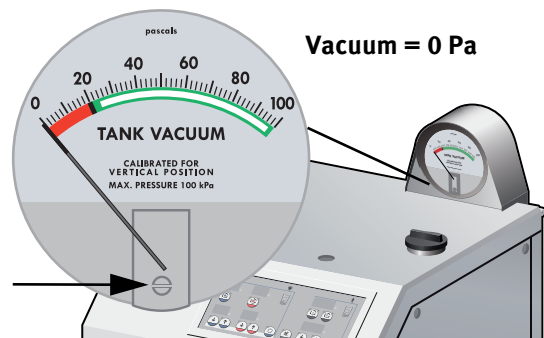

Continue step on next page ▶

- ▣ 2 Check the installation date on the aerosol collection canister.

If more than 7 days have passed since the installation date, dispose of the aerosol collection canister and install a new one according to chapter 4.5.

No more than 7 days old

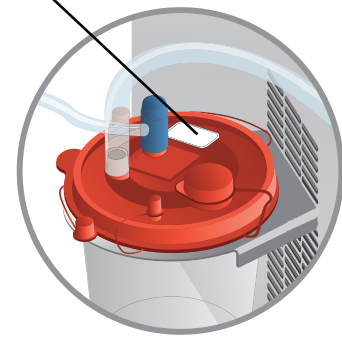

- ▣ 3 Power on the external vacuum source and set the vacuum regulator to full open flow.

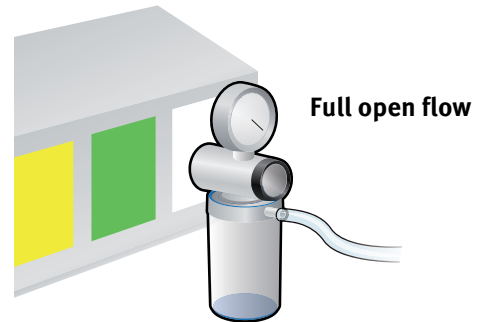

- ▣ 4 Make sure that the heater-cooler's vacuum gauge reads greater than 50 Pa.

**NOTE:** With full open vacuum flow, the heater-cooler's vacuum gauge might read greater than 100 Pa. The vacuum gauge can accept full vacuum flow.

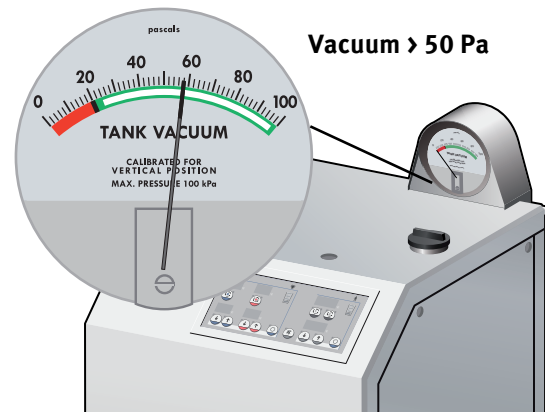



## 2

### Power on the heater-cooler and observe the self-test

- ▣ 1 Press the mains power switch to power on the heater-cooler.

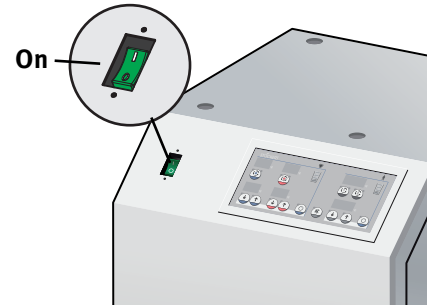

- ▣ 2 The heater-cooler will run a self-test while powering up. All of the control panel's LEDs and 7-segment displays will illuminate for 2 seconds, and a tone will sound.

Check that all LEDs and 7-segment displays are properly illuminated before use.

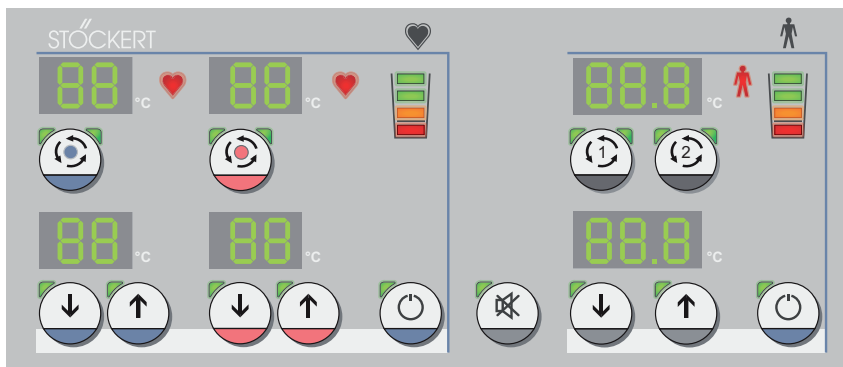

- ▣ 3 After the control panel lights up, the device's software version number (EPROM) will display for 1 second in the patient circuit display.
- ▣ 4 The heater-cooler is now finished powering on and will display the last set temperature values. The heater-cooler is now actively controlling the tank temperatures, but the circuit pumps are not running.

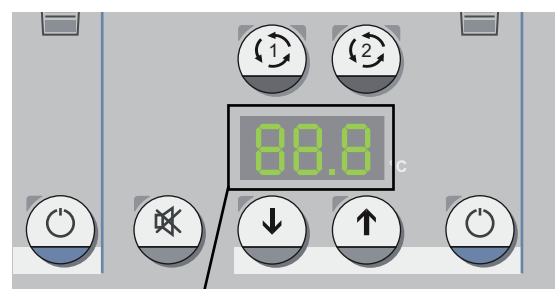

**Version number appears in patient circuit display**

### 3

## Check the control panel to confirm the heater-cooler is ready for use



### Important

**Do not** use the heater-cooler if the elements on the control panel are flashing. If the control panel is flashing, the heater-cooler is in service mode. Power off the heater-cooler and power it on again to exit service mode.

- ▣ 1 Once the self-test is complete, confirm the following:
  - The green LEDs of the Standby buttons are not illuminated (i.e., the circuits are not in standby mode).
  - The control panel displays the last set temperature values.
  - Both circuit water level displays are illuminated to the second green segment.
- ▣ 2 The heater-cooler is ready for use.

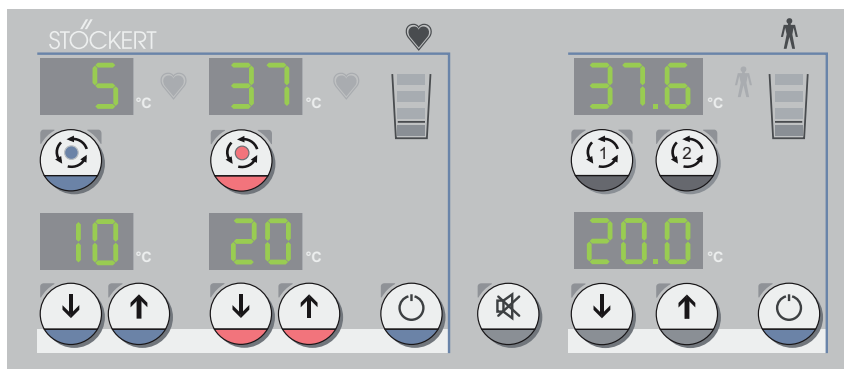

## If errors EE(E) appear on control panel

If a circuit's set point display flashes between "EE(E)" and a number, this is an error code:

- Error code E08, E19, or E23 might display during priming, but should clear when priming completes (all air is removed from the circuit).
- Do not use a circuit if an error code remains after priming. Refer to chapter 8.1.4 for error code definitions, and notify your authorized service technician as soon as possible.

**NOTE:** You may use the unaffected circuits even if one circuit displays an error code.



Flashes between error and code number

## 5.4 Performing a functional check prior to operation



### Important

- Perform the steps outlined in this chapter before every time you use the heater-cooler.
- Address any error codes immediately. Depending on the error code, you might not be able to use a particular circuit, or you might not be able to use the heater-cooler at all. Refer to chapter 8.1.4 for error code descriptions.
- The heater-cooler is ready for operation after you have performed the functional check.

### Summary of steps you will complete in this section

1

Check the setup

2

Check when first switching power on

# 1

## Check the setup

- ✓ Confirm the heater-cooler's and portable vacuum source's (if applicable) exhaust is pointed away from the operating field.



### WARNING

**Do not** position the heater-cooler's and portable vacuum source's (if applicable) exhaust flow directed toward the operating field. Position the exhaust flow away from the operating field and toward the exhaust vent system.

- ✓ Confirm that the heater-cooler is positioned on a level, even floor.
- ✓ Confirm that the castor brakes are locked.
- ✓ Confirm that the power cable and potential equalization cable have been connected according to applicable regulations.
- ✓ Confirm that the mains plug is completely dry.
- ✓ Confirm that the power cable is free of damage.
- ✓ Confirm that all tubing connectors are secure and locked.
- ✓ Confirm that all procedural tubings are free of damage and leaks.
- ✓ Confirm that the aerosol collection set is less than 7 days old.
- ✓ Confirm that the aerosol collection canister is holding less than 0.5 L of fluid.
- ✓ Confirm that the heater-cooler's vacuum gauge reads greater than 50 Pa with full open vacuum flow applied.
- ✓ Confirm that a replacement heater-cooler with compatible connectors is available.
- ✓ Confirm that the CAN cable is properly connected (if you are operating the heater-cooler with a S5/C5 System).

## 2

### Check when first switching power on

- ✔ Confirm that all LEDs and temperature displays on the control panel are illuminated.
- ✔ Confirm that a tone sounded.
- ✔ Confirm that the control panel is reflective of a functioning heater-cooler (i.e., the heater-cooler is not in service mode and does not display errors). If the heater-cooler displays an error, refer to chapter 8.1.4 for error code descriptions.
- ✔ Confirm that the water level indicators on the patient and cardioplegia circuit displays are not blinking orange or solid red.

## 5.5 Priming the complete circuit

### Summary of steps you will complete in this section

- 1 Adjust the set values as needed
- 2 Place unused circuits in standby mode
- 3 Prime the external circuits

### 1 Adjust the set values as needed



#### Important

The heater-cooler will begin adjusting temperatures to the set values 2 seconds after the last Set value button press.

- ▣ To adjust the set values:
  - Press the Set value up button to raise the circuit temperature.
  - Press the Set value down button to lower the circuit temperature.

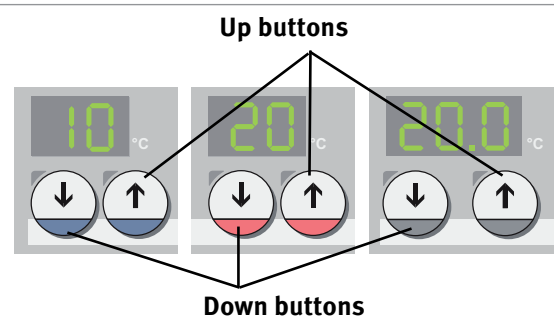

### 2 Place unused circuits in standby mode

- ▣ If not being used, press the circuit's Standby button to place the circuit on standby.

**NOTE:** The other circuit will continue to function and the heating/cooling performance will be increased.

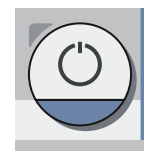

Standby buttons

### 3 Prime the external circuits



#### Important

Prime the circuits' tubings and heat exchanger before using the heater-cooler.

- When you power on a circuit for the first time, an error code might appear indicating that air is present in the tubings.
- Do not use the heater-cooler until you have resolved the errors by completely priming the external circuits.

- ▣ 1 On the back of the heater-cooler, for any circuits with tubing connected, turn the red levers counterclockwise to open the valves.

Open valves connected to tubing

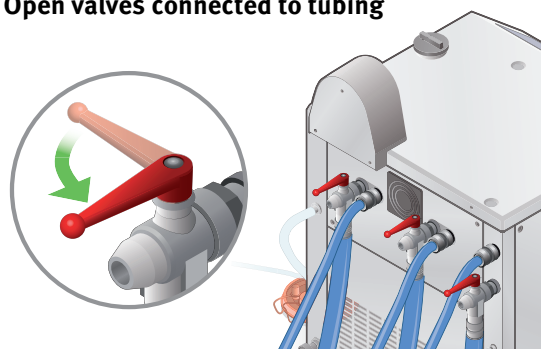

- ▣ 2 Prime the cardioplegia circuit using the **cold cardioplegia** tank.

Use **cold cardioplegia** circuit to prime

**NOTE:** Do not use the warm cardioplegia tank to prime. This will trigger an error code and stop the circuit pump.

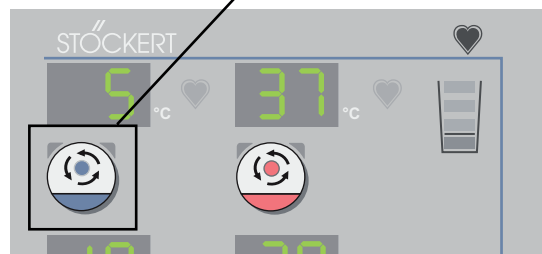

Continue step on next page ▶



- ▣ 3 Prime the patient circuit(s) using the associated pump(s).

**NOTE:** Do not run a pump if there is no tubing connected.

**Prime patient 1 and patient 2 circuits**

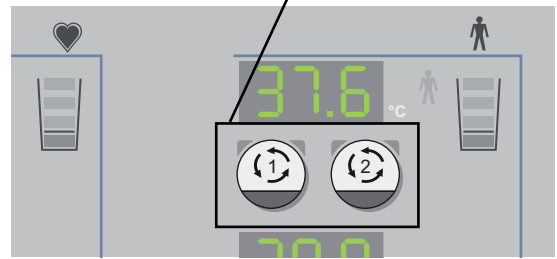

- ▣ 4 Depending on the volume of the circuit tubing, you might need to refill the water tanks after priming. Check the water level displays:
  - Make sure the first or second green segments on both water level displays are illuminated.
  - If not, refill the water tanks before use according to chapter 4.7, step 1 and step 2.

**Acceptable volume  
Cardioplegia or patient circuits**



**Unacceptable volume  
Cardioplegia or patient circuits**



## 5.6 Using the device controls during a procedure

### 5.6.1 Checking the vacuum

#### Checking the vacuum

Adjust the external vacuum source to full open vacuum flow to check that the heater-cooler operates at vacuum levels greater than 50 Pa.

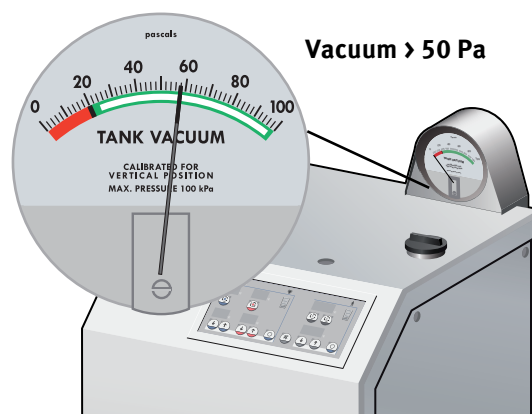

#### WARNING

Operating the heater-cooler with the vacuum level indicated on the tank vacuum gauge in the red solid zone limits the aerosol collection set's ability to collect aerosol from the water tanks. Refer to chapter 8.2.1 for possible remedies.

## 5.6.2 Opening and closing the circuit valves



### Important

- To fill the tubing and to run water through the circuits, the valves must be open.
- To drain tubing, the valves must be closed.

### Opening a valve

On the back of the heater-cooler, for any circuits with tubing connected, turn the red levers counterclockwise to open the valves.

#### Open valves connected to tubing

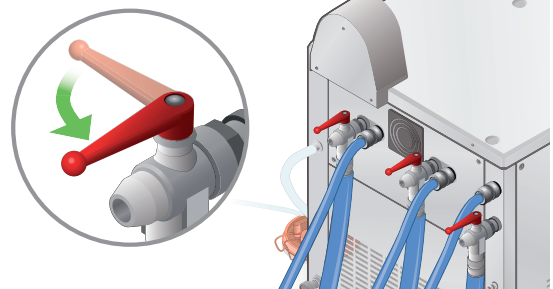

### Closing a valve

On the back of the heater-cooler, turn the red valve lever clockwise to close the valve.

#### Close valves

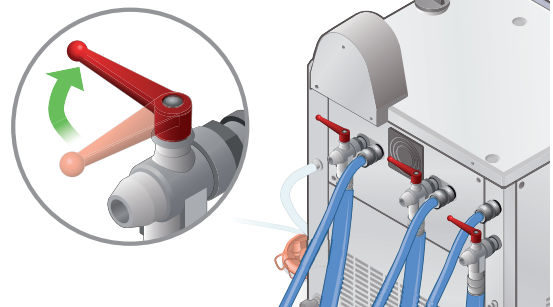

## 5.6.3 Using the circuit controls

### Adjusting the set values



#### Important

The heater-cooler will begin adjusting temperatures to the set values 2 seconds after the last Set value button press.

To adjust the set values:

- Press the Set value up button to raise the circuit temperature.
- Press the Set value down button to lower the circuit temperature.

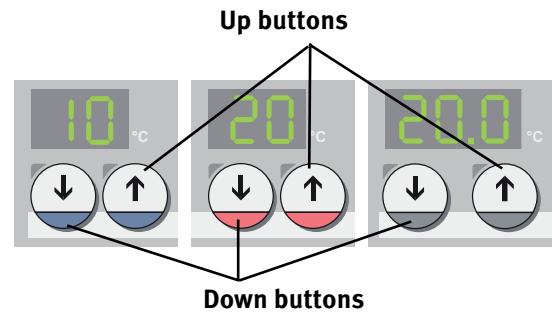

#### Special Set value button operations:

**Cardioplegia:** Pressing and holding a Set value button changes the temperature value by 1 °C. Continuing to hold the Set value button will increase or decrease the set value more rapidly.

**Patient:** Pressing and holding a Set value button initially changes the temperature value by 0.1 °C, then changes the temperature value by 1 °C. If you then release the Set value button and immediately press it once, the temperature value will still change by 1 °C.

You can increase the temperature value change increment by pressing and holding one Set value button and pressing its counterpart (i.e., up or down) once.

## Operating the cardioplegia circuit

### How the cardioplegia circuit works:

The cardioplegia circuit has two tanks: a warm tank and a cold tank. The warm and cold cardioplegia tanks operate using a single circuit. Only one cardioplegia circuit (warm or cold) can run at a time.

You can control each tank's temperature independently so that warm and cold water sources are available on demand during a procedure.

The temperature range for the **cold cardioplegia** tank is: 2 °C to 10 °C.

The temperature range for the **warm cardioplegia** tank is: 15 °C to 41 °C.

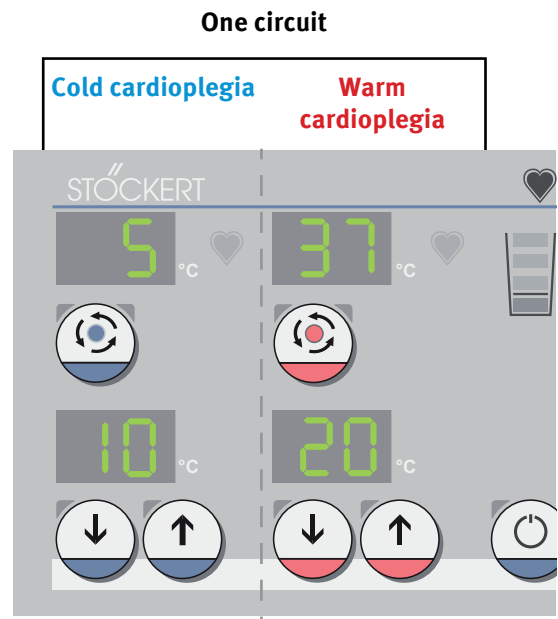

### Starting the cardioplegia circuit:

Press the Start/Stop button of your desired cardioplegia circuit to run the circuit.

The water from the selected cardioplegia circuit's tank (warm or cold) will fill the cardioplegia circuit.

**NOTE:** The green LEDs will flash alternately to indicate the circuit is running.

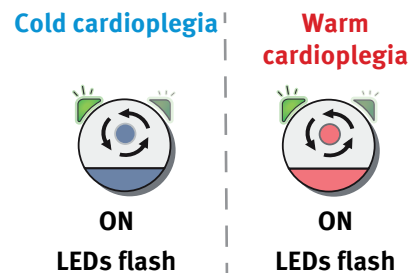

### Switching between cardioplegia tanks (warm or cold):

Press the Start/Stop button of the inactive cardioplegia tank to run the circuit.

Within 5 seconds, the active cardioplegia circuit will stop running, and the water from the selected cardioplegia circuit's tank (warm or cold) will fill the cardioplegia circuit.

**NOTE:** The green LEDs will flash alternately to indicate the circuit is running.

Start one cardioplegia circuit and the other will stop

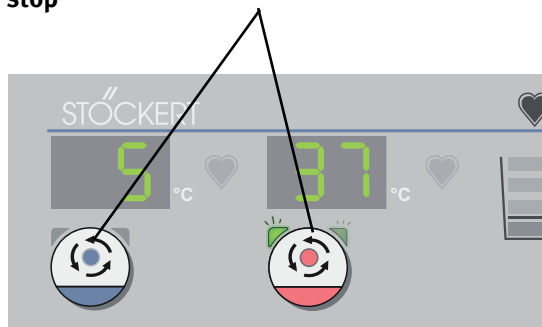

### Stopping the cardioplegia circuit:

Press the Start/Stop button of the active cardioplegia circuit to stop the circuit.

The cardioplegia circuit will stop running.

**NOTE:** The green LEDs will go out when the cardioplegia circuit stops running.

Cold cardioplegia



OFF  
LEDs off

Warm cardioplegia



OFF  
LEDs off



### Important

Put the cardioplegia circuit in standby when it is not in use. Leaving the cardioplegia circuit active reduces the patient circuits' heating/cooling performance.



Cardioplegia  
Standby button

## Operating the patient circuits

### How the patient circuits work:

The patient 1 and patient 2 circuits operate using separate circuit valves and pumps. Both patient circuits can run at the same time.

The patient 1 and patient 2 circuits use the same water tank. The temperature of both patient circuits will always be the same.

The temperature range for the patient tank is 2 °C to 41 °C.

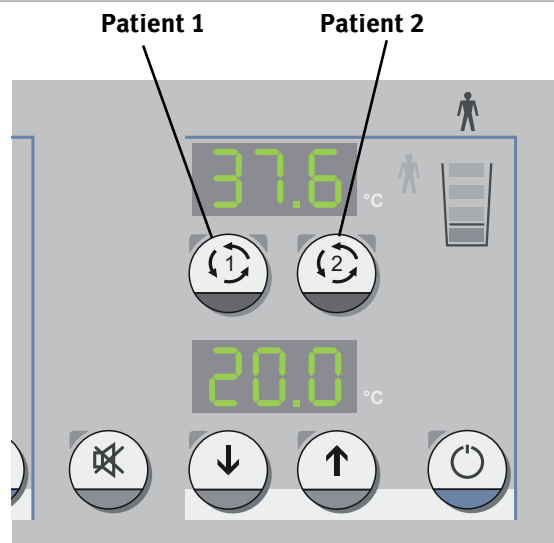

### Starting the patient circuit(s):

Press the Start/Stop button of your desired patient circuit to run the circuit.

**NOTE:** The green LEDs on the patient(s) circuit(s) will flash alternately to indicate the circuit is running.

Patient 1



**ON**  
LEDs flash

Patient 2



**ON**  
LEDs flash

### Stopping the patient circuit(s):

Press the Start/Stop button of the active patient circuit(s) to stop the circuit(s).

**NOTE:** The green LEDs will go out when the patient(s) circuit(s) stops running.

Patient 1



**OFF**  
LEDs off

Patient 2



**OFF**  
LEDs off



### Important

Put the patient circuits in standby when they are not in use. Leaving the patient circuits active reduces the cardioplegia circuits' heating/cooling performance.



**Patient Standby  
button**

## 5.7 Completing a procedure



### WARNING

**Do not empty the external circuits** until the patient has been discharged from the OR environment to reduce the potential of exposure to aerosol.

### 5.7.1 Drain and disconnect tubing

#### Summary of steps you will complete in this section

- 1 Confirm the patient is not in the room
- 2 Prepare the heater-cooler for draining
- 3 Drain the external circuits
- 4 Disconnect the tubing from the external devices
- 5 Power off the heater-cooler



# 1

## Confirm the patient is not in the room

- ▣ Confirm that the patient has been discharged from the OR before conducting any further steps.

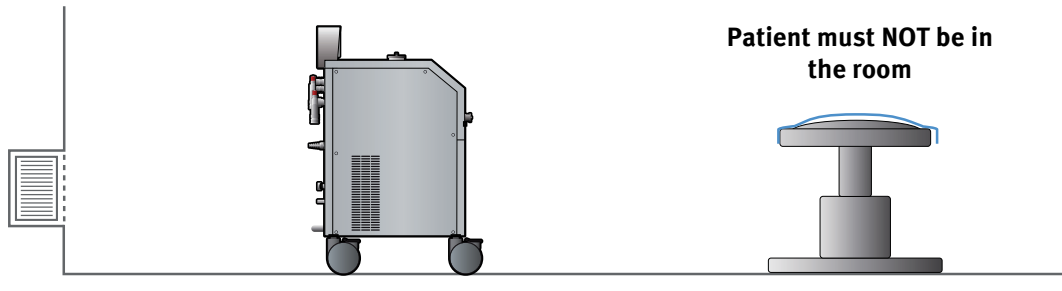

## 2

### Prepare the heater-cooler for draining

- ▣ 1 Make sure that the heater-cooler is powered **on** when draining. If needed, press the mains power switch to power on the heater-cooler.

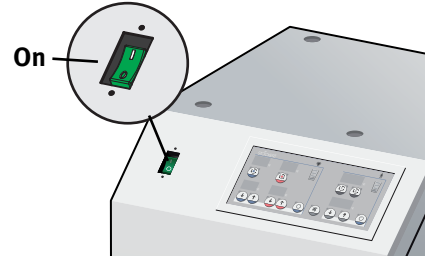

- ▣ 2 Make sure that the aerosol collection set is connected and the vacuum source is connected and set to maximum.

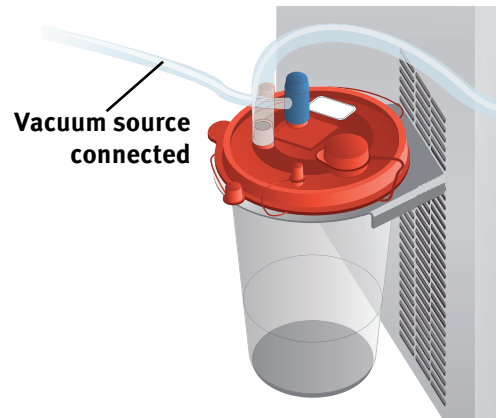

#### WARNING

**Do not shut off the applied vacuum source** until you have drained the circuits and powered off the heater-cooler. Operate the heater-cooler with an applied vacuum source to ensure that aerosol continues to be collected from the water tanks.



#### Important

If you are draining longer tubes with high volumes, there is a potential for overflowing the aerosol container. If the volume in the container exceeds 0.5 L, pause the draining of the circuit and empty the aerosol container according to chapter 5.7.2, then continue draining.

Continue step on next page



- 3 To prevent excess overflow, drain water from the patient circuit tank until the **orange segment** on the patient circuit water level display flashes.

Close the drain valve after draining this amount from the tank.

Drain patient circuit until **orange segment** displays

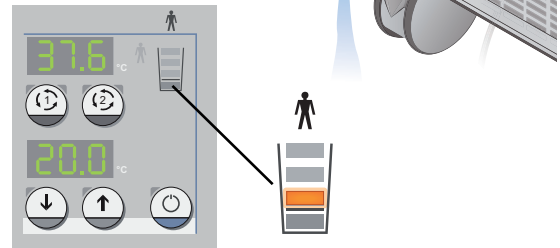

### 3

## Drain the external circuits



### WARNING

Do not close all valves at once when draining water circuits. Always close one circuit valve at a time. Failure to close the external water circuit valves in the order specified below may result in increased levels of aerosol emission.

- 1 Make sure that the circuit pumps are running on any circuits that are connected. Press the Start/Stop buttons if needed.

**NOTE:** The green LEDs will flash alternately to indicate the circuit is running.

### Example of Start/Stop buttons:

Warm cardioplegia



ON

LEDs flash

Patient 1



ON

LEDs flash

Continue step on next page ▶

- 2 With either cardioplegia pump running, turn the **cardioplegia circuit's** red valve lever clockwise to close the valve.

Allow the external water circuit volume to enter the tank before closing the next valve.

Close cardioplegia valve, wait to drain

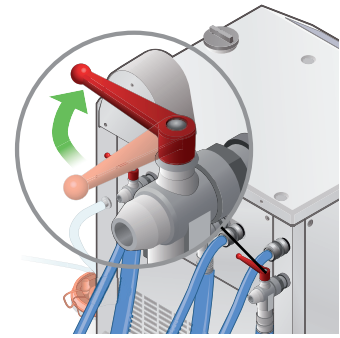

- 3 Turn the **patient 1** circuit's red valve lever clockwise to close the valve.

Allow the external water circuit volume to enter the tank before closing the next valve.

Close patient 1 valve, wait to drain

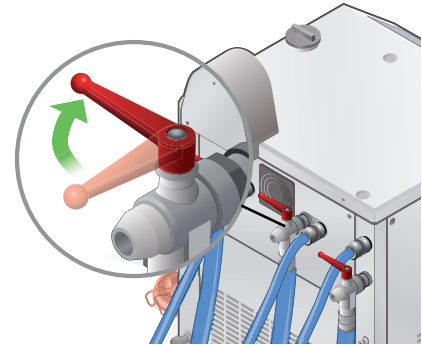

- 4 If in use, turn the **patient 2** circuit's red valve lever clockwise to close the valve.

The water from the external circuit will return to the patient circuit tank.

Close patient 2 valve, wait to drain

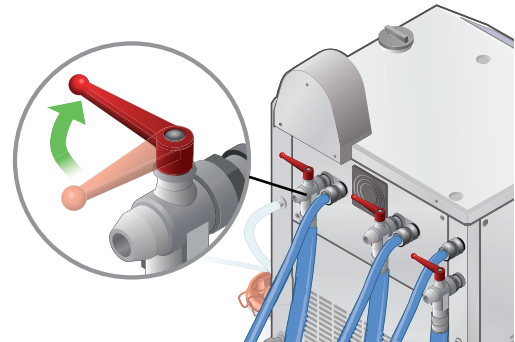

- 5 Press the Start/Stop button of the active circuit(s) to stop the circuit(s).

**NOTE:** The green LEDs will go out when the circuit(s) stops running.

Example of Start/Stop buttons:

Warm cardioplegia



OFF  
LEDs off

Patient 1



OFF  
LEDs off

## 4

### Disconnect the tubing from the external devices

- ▣ 1 Make sure that the circuits are drained before disconnecting any tubing.
- ▣ 2 Disconnect all procedural tubing from external devices.
- ▣ 3 Disconnect the procedural tubing from the heater-cooler  
**OR**  
Disinfect the tubing connectors and suitable short-circuit connectors (part number 73-300-160). Then, short-circuit the procedural tubing.

Connect tubing

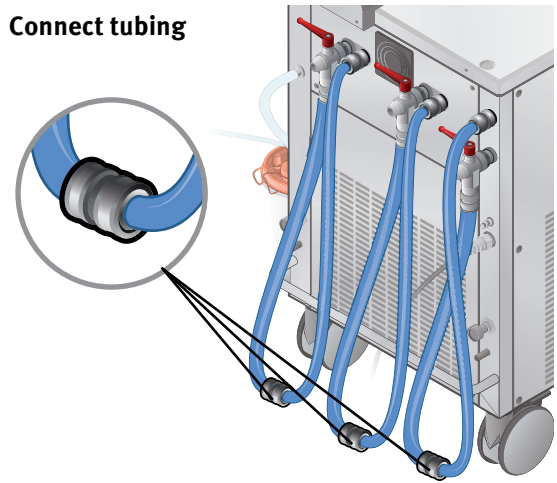

#### Important

Disinfect the connectors and fittings every time you make a connection according to chapter 6.3.2 and chapter 6.3.3.

## 5

### Power off the heater-cooler

- ▣ Press the mains power switch to power off the heater-cooler. The vacuum source may now be shut off and/or disconnected.

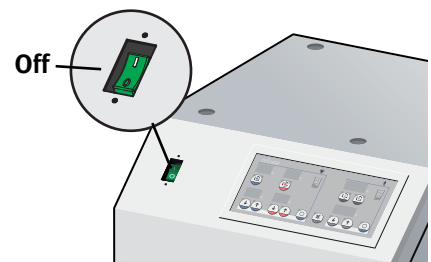

## 5.7.2 Emptying and/or disposing of the aerosol collection set

### Summary of steps you will complete in this section

- 1 Empty the aerosol collection canister
- 2 Dispose of and replace, or reconnect the aerosol collection set based on the date it was installed

### 1 Empty the aerosol collection canister



#### WARNING

The aerosol collection canister contents are potentially hazardous due to collection of bacteria. Use appropriate Personal Protection Equipment (PPE), and handle the contents accordingly.



#### CAUTION

Do not expose the aerosol collection canister's hydrophobic lid filter to the water inside the aerosol collection canister. This will seal the filter, which will stop vacuum flow and limit the aerosol collection canister's ability to collect aerosol from the heater-cooler's water tanks.

If the hydrophobic lid filter has been exposed to water, replace the aerosol collection set according to the steps in this chapter.

- 1 Make sure that the heater-cooler is powered **OFF**. If needed, press the mains power switch to power off the heater-cooler.

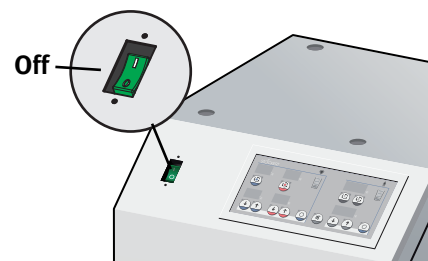

Continue step on next page ▶



**CAUTION**

**Do not** disconnect the vacuum source if the heater-cooler is powered on.

- 2 Disconnect the **vacuum source line** (the long line) from the vacuum regulator.

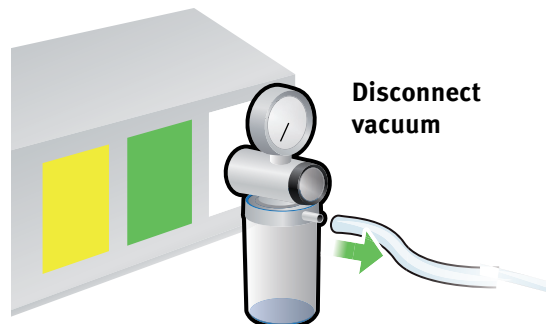

- 3 Disconnect the **heater-cooler connection line** and **vacuum source line** from the canister lid.
- 4 If you are disposing of the aerosol collection set (instead of only emptying), also disconnect the **heater-cooler connection line** from the back of the heater-cooler.

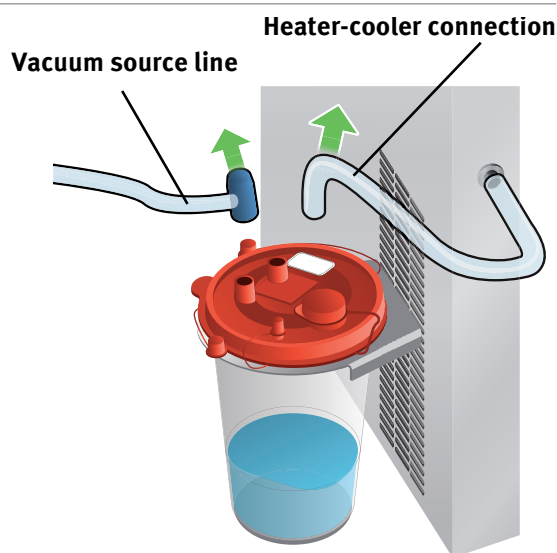

- 5 Lifting from the canister body, carefully remove the aerosol collection canister from the holder.

**NOTE: Do not** lift the aerosol collection canister by the lid, as the weight of the contents might cause the lid to separate from the aerosol collection canister.

**DO NOT lift by lid.  
Lift canister body**

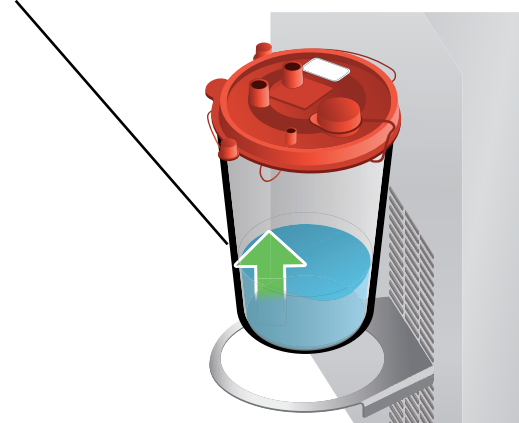

Continue step on next page ▶

- ▣ 6 Uncap the **pour spout** on the aerosol collection canister.



**CAUTION**

**Do not** expose hydrophobic filter in Canister Lid to water when emptying the canister. Exposure to water will block filter and cause it to not function.

- ▣ 7 Empty the aerosol collection canister in accordance with your hospital's policies.

**NOTE:** Empty the aerosol collection canister outside of the OR, if possible.

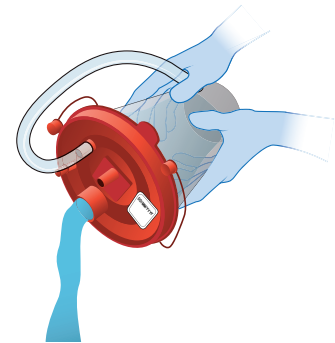

- ▣ 8 Recap the **pour spout** on the aerosol collection canister.

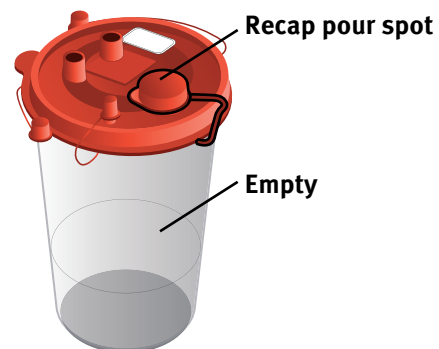



## 2

### Dispose of and replace, or reconnect the aerosol collection set based on the date it was installed

- ▣ 1 Check the installation date written on the aerosol collection canister lid:
  - **If the aerosol collection set is less than 7 days old**, you may reconnect the emptied canister using the same heater-cooler connection line and vacuum source line. Or, you may replace the entire aerosol collection set.
  - **If the aerosol collection set is more than 7 days old**, replace the entire aerosol collection set including all its components and lines.
- ▣ 2 Follow the applicable steps in chapter 4.5 to connect a new or emptied aerosol collection set to the heater-cooler.



## 5.7.3 Conducting any required maintenance according to schedule

### 1

#### Clean and disinfect the heater-cooler surfaces after every use

- ▣ Clean and disinfect the heater-cooler surfaces after every use according to the instructions in chapter 6.3.



### 2

#### Review the schedule for disinfection and maintenance

- ▣ Review the schedule for disinfection and maintenance in chapter 6.2.1 to determine if any additional maintenance, cleaning, and/or disinfection tasks are required.

# 6 Maintaining the heater-cooler

**Regular maintenance is an important factor for the operation of the heater-cooler as it results in operational safety, reliability and increased service life.**

This chapter provides instructions for the routine maintenance that is part of the operating conditions for the heater-cooler. This applies to the routine maintenance performed by the responsible organization as defined in IEC 60601-1 or the equivalent national standard, as well as to the preventive maintenance and safety checks performed by LivaNova representatives or competent service personnel.

## 6.1 General maintenance precautions

### 6.1.1 Safety instructions for routine maintenance



#### **WARNING**

**It is important to follow the cleaning and disinfection process described in these operating instructions to help reduce the risk of contamination.**

#### **Personnel and preparation:**

- Only individuals trained to use the heater-cooler should perform maintenance on the heater-cooler.
- Only service technicians authorized by LivaNova may repair the heater-cooler system.
- Only refrigerant systems experts are authorized to repair the cooling circuit.
- Do not service the internal components of the heater-cooler. Only LivaNova representatives — or other service personnel deemed qualified by LivaNova — are authorized to maintain, service, and repair internal components of the heater-cooler.

#### **Materials and protective equipment:**

- When performing any maintenance activities on the heater-cooler, follow your hospital's personal protection equipment (PPE) policy to protect against exposure to hazardous materials, such as bacteria and/or disinfectant chemicals.



## CAUTION

### Materials and protective equipment:

- Use only cleaning agents and disinfectants that are approved for use in the concentrations specified in chapter 6.3 and 6.4.1. Deviating from the labeling could cause damage to the heater-cooler.

### Timing:

- Conduct regular maintenance of the heater-cooler. Doing so will result in operational safety, reliability, and increased service life.
- Perform all cleaning and disinfecting procedures according to the maintenance schedule provided in chapter 6.2.
- Disinfect the heater-cooler before using it for the first time. Disinfect the heater-cooler before storage.

## NOTICE

- Adhere to local regulations related to documenting all maintenance procedures, as required by European Directive 93/42, and any operating failures in a medical device log. The medical device log should be presented to authorized service personnel upon request.

**NOTE:** LivaNova recommends documenting this information regardless of local regulations. Providing this information to LivaNova will assist with maintenance and support activities.

- Exposing the heater-cooler to disinfectant for longer than its intended exposure time will increase the wear on the device and might lead to premature failure of the heater-cooler.
- All ventilation grills must be cleaned at regular intervals to avoid contamination. Detailed information on this subject is provided in chapter 6.8.

## 6.2 Maintenance schedule and checklists

This chapter includes a schedule of maintenance tasks and several checklists you should use to make sure that the heater-cooler is properly maintained, disinfected, and functioning.

### 6.2.1 Schedule: Disinfection and maintenance

Timing	Task	Chapter
Before first-time use, before storing	Clean and disinfect external surfaces, connectors, and fittings	6.3
	Disinfect the water circuits	6.4
Upon every connection	Disinfect connections and fittings	6.3.3
After every use	Clean and disinfect external surfaces	6.3.1
Daily, before use Daily, when in storage	Monitor the hydrogen peroxide concentration	6.5.1
Every 7 days	Replace the aerosol collection set	5.7.2
Every 7 days	Change the water and add hydrogen peroxide	6.6
Every 14 days (including when in storage)	Disinfect the water circuits	6.4
Once a month	<ul style="list-style-type: none"> <li>● Monitor the water quality for total bacteria count</li> <li>● Monitor the water quality for NTM</li> </ul> <p><b>NOTE:</b> Conduct <b>before and after</b> disinfecting the water circuits</p>	6.5.2
Once a year	Replace the tubings used with the heater-cooler	6.9
Once a year or 1,000 hours (which ever comes first)	Schedule a maintenance check after every 1,000 operating hours or at least once every 12 months, whichever comes first.	6.2.4

## 6.2.2 Checklist: Daily or with every use

### 1

#### Perform these checks daily or every time you use the heater-cooler

- ✔ Check the maintenance schedule in 6.2.1 to determine whether any maintenance activities are due. Perform the required maintenance activities according to their corresponding instructions.
- ✔ Make sure that the daily monitoring of the hydrogen peroxide concentration has been completed per 6.5.1.
- ✔ Dispose of used single-use items according to local environmental regulations and the manufacturer's instructions.
- ✔ Check the installation date on the aerosol collection canister.
  - If more than 7 days have passed, replace the aerosol collection canister. Refer to chapter 5.7.2 for instructions on replacing the aerosol collection set.
  - If 7 days or fewer have passed, check the fill level on the aerosol collection set and empty it if needed, according to instructions in chapter 5.7.2.
- ✔ Contact LivaNova if the heater-cooler or any of its components are defective or damaged.

## 6.2.3 Checklist: Mechanical checks

- **Perform regular checks** to ensure that the heater-cooler is in proper working condition, and to reduce or eliminate the chance of malfunction.
- **Do not use** the heater-cooler if the heater-cooler does not meet all the conditions listed in this chapter.
- **Contact LivaNova** if the heater-cooler or any of its components are damaged or require service.

### 1

#### Check the heater-cooler's main power, potential equalization, and CAN cable

- ▣ Make sure:
  - ✓ The cables are free of damage (e.g., cracks, cuts, kinks) along the entire length of the cable
  - ✓ All contacts are clean
  - ✓ The plugs are free of mechanical damage (e.g., no damage to housing and no bent pins)
  - ✓ The mains power connection to the heater-cooler is secure with no movement between cable and strain relief

### 2

#### Check the water circuits

- ▣ Make sure:
  - ✓ Water tubing is free of damage and leaks
  - ✓ Water circuit connections are free of damage and leaks
  - ✓ Water circuit connectors lock and unlock smoothly



## 6.2.4 Checklist: Regular maintenance from LivaNova

**You/your organization is responsible** for scheduling maintenance checks from a LivaNova service technician.

**Only LivaNova representatives** — or other service personnel deemed qualified by LivaNova — are authorized to perform maintenance checks of the heater-cooler.

Maintenance checks by LivaNova service technicians include, but are not limited to, the following:

- Status checks
- Electrical safety checks
- Operational safety checks
- Status of the water circuits/tanks for calcification and biofilm
- Status of cooling coils for corrosion
- Decalcification and/or disinfection



### **Important**

As a preventive measure, contact LivaNova service personnel to schedule a maintenance check of the water tank cooling coils if you observe either of the following:

- Dark gray liquid is observed during the water circuit disinfection process.
- Excessive hydrogen peroxide consumption is observed during the daily monitoring of hydrogen peroxide concentration.

Note: The rate of decrease in hydrogen peroxide concentration is expected to vary by device, and depends on several factors such as age or overall condition of the device, past maintenance practices, and local water conditions.



### **Important**

The expected service life of the Heater-Cooler System 3T is 10 years. Use of the device beyond the expected service life, improper maintenance practices, or the incorrect use of disinfection and water preservation chemicals may lead to excessive corrosion damage of the water circuit components.

## 1 Record or estimate the operating hours

- ✓ Where required by local regulations, record the operating hours of the heater-cooler.<sup>1</sup>
- ✓ If local regulations do not require tracking of operating hours, LivaNova recommends estimating the operating hours.

## 2 Schedule a maintenance check

- ☐ Schedule a maintenance check with a LivaNova service technician every 1,000 operating hours or every 12 months, whichever comes first.

### 6.2.5 Checklist: Proper disposal

#### 1 Dispose of the heater-cooler and/or accessories according to your local environmental regulations and hospital policy

- ✓ Dispose of used single-use items according to local environmental regulations and the manufacturer's instructions. Wear appropriate personal protection equipment (PPE) while disposing of these items.
- ✓ The heater-cooler must not be disposed of in accordance with Directive 2012/19/EU or its national transpositions as the system is to be regarded as potentially infectious at the end of its service life.
- ✓ Dispose of all heater-cooler accessories according to your hospital's policy, local environmental regulations, and the accessories' instructions.
- ✓ Only refrigerant systems experts are authorized to dispose of the cooling circuit's refrigerant (CFC-free HFC-[hydrofluorocarbons]) refrigerant. The refrigerant system service information is contained on the refrigerant system label.

1 As required by European Directive 93/42 and/or local regulation

## 6.3 Cleaning and disinfecting external surfaces, connectors, and fittings

### Cleaning and disinfecting schedule

- **After every use**, clean and disinfect the device surfaces
- **Upon every connection**, disinfect the tubing connectors on the heater-cooler
- **Upon every connection**, disinfect the fittings and connectors on the tubing



#### Important

- Make sure the CAN jack cover is closed before cleaning and disinfecting.
- Use only disinfectant wipes and sprays that are approved for use with the heater-cooler. See the table below for a list of approved cleaning supplies.

### Approved pre-soaked disinfectant wipe

Product name	Manufacturer
CaviWipes	Metrex

### Approved disinfectant spray

Product name	Manufacturer
CaviCide	Metrex

## 6.3.1 Cleaning and disinfecting heater-cooler external surfaces

Summary of steps you will complete in this section:

- 1 Clean and disinfect the vacuum gauge
- 2 Clean all accessible device surfaces
- 3 Disinfect all accessible device surfaces

### 1 Clean and disinfect the vacuum gauge

- ☑ 1 Using **only approved disinfectant wipes**, clean the vacuum gauge, removing any surface contamination and liquid spills.
- ☑ 2 Using **only approved disinfectant wipes**, disinfect the vacuum gauge.

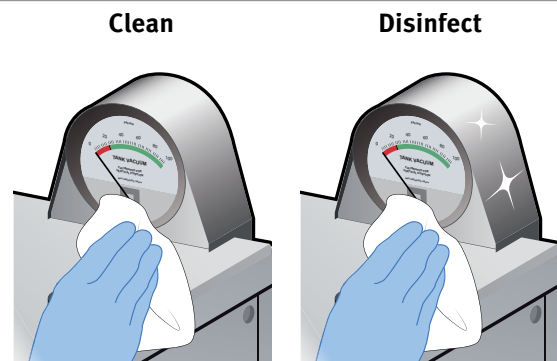

#### Important

Using other disinfectants may result in damage or a shortened lifetime of the gauge face.

## 2

### Clean all accessible device surfaces

- ▣ 1 Remove liquid spills (such as blood) from the device surfaces as quickly as possible.
- ▣ 2 Remove any surface contamination using pre-soaked disinfectant wipes.
- ▣ 3 Dispose of used disinfectant wipes in accordance with your hospital's policies.

#### Clean all surfaces



## 3

### Disinfect all accessible device surfaces

- ▣ 1 Thoroughly wipe all device surfaces using pre-soaked disinfectant wipes per the wipes' instructions for use and your hospital's policies.
- ▣ 2 Wait for the exposure time specified by the disinfectant wipes you are using.
- ▣ 3 Dispose of used disinfectant wipes in accordance with your hospital's policies.

#### Disinfect all surfaces



## 6.3.2 Disinfecting the tubing connectors on the heater-cooler

### 1

#### Disinfect tubing connectors on the heater-cooler



#### Important

Make sure that no liquids enter the housing of the heater-cooler when spraying disinfectant.

- ▣ 1 Conduct steps ▣ 2 and ▣ 3 on all tubing connector inlets and outlets:
  - **Patient 2** connectors
  - **Patient 1** connectors
  - **Cardioplegia** connectors

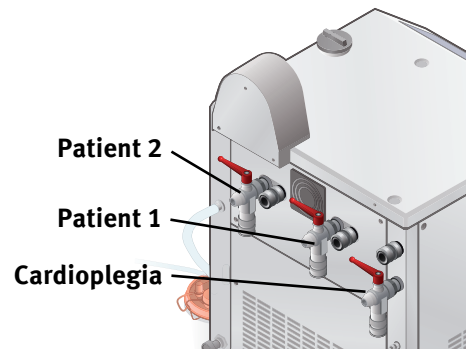

- ▣ 2 Apply four sprays of disinfectant on the exterior of each connector. Push and hold the quick release ring back and apply four sprays of disinfectant to the interior of each connector.

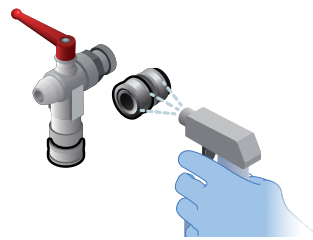

- ▣ 3 Wait for 5 minutes. Ensure that all connector surfaces remain wet with disinfectant during this time. Apply additional disinfectant if necessary.

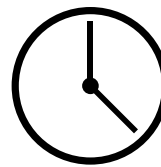

**Wait for 5 minutes, then wipe off excess for 2 minutes**

Wipe all connector surfaces with a disinfectant wipe for 2 minutes to remove excess disinfectant.

## 6.3.3 Disinfecting the fittings and connectors on the tubing

### 1

#### Disinfect all connectors and fittings on the tubing

- ▣ 1 Conduct steps ▣ 2 through ▣ 4 on all fittings and connectors on short circuit and procedural tubing.

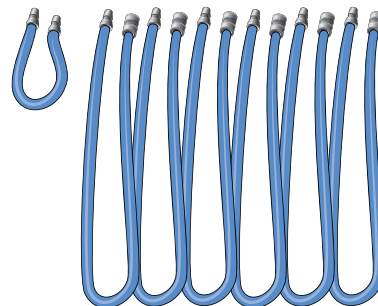

- ▣ 2 Apply four sprays of disinfectant on the male fitting.

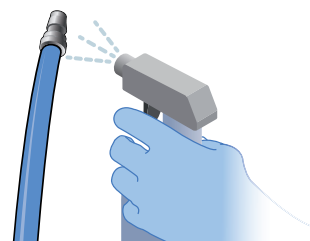

- ▣ 3 On the other end of the tube, apply four sprays of disinfectant on the exterior of the female connector. Push and hold the quick release ring back and apply four sprays of disinfectant to the interior of each connector.



- ▣ 4 Wait for 5 minutes. Ensure that all surfaces remain wet with disinfectant during this time. Apply additional disinfectant if necessary.

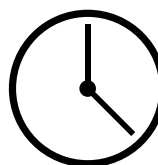

**Wait for 5 minutes, then wipe off excess for 2 minutes**

Wipe all surfaces with a disinfectant wipe for 2 minutes to remove excess disinfectant.

## 6.4 Disinfecting the water circuits every 14 days

### Water circuit disinfecting schedule

- Disinfect the water circuits every 14 days, regardless of water changes.
- Take water samples before and after disinfecting the system if you are scheduled to monitor the water for bacteria and/or NTM.
- Disinfect the water circuits before using the heater-cooler for the first time and before storing the heater-cooler.



#### Important

- Be sure to disinfect the procedural tubing typically used with the heater-cooler.
- Follow your hospital's policies regarding the use of personal protective equipment (PPE).



## 6.4.1 Supplies and materials for disinfection



### WARNING

Do not use disinfectants in the water circuits during a surgical intervention. Only use disinfectants preoperatively and postoperatively.



### Important

- Use only LivaNova-approved disinfectants to disinfect the water circuits. The use of any other disinfectant is explicitly not recommended. Other disinfectants could contain different additives that might influence the material compatibility, even if they have the same peracetic acid or sodium hypochlorite concentration.
- Refer to your disinfectant's instructions for use for details related to your specific disinfectant.
- Refer to your disinfectant's safety data sheet for information regarding personal protection measures.

## List of the approved disinfectants

Product name	Manufacturer	EPA Reg. No.
Clorox Germicidal Bleach (8.25% sodium hypochlorite)	Clorox Company	5813-100-67619
Minnicare Cold Sterilant	Minntech Corporation	52252-4

Check the availability of the recommended disinfectants in your country, if applicable.

---

## Materials you will need

### Materials to fill the water tanks

- Tap water filtered according to chapter 1.1.9
- Tubing required to connect the filter to your hospital's faucet or water supply

### Materials to disinfect the water circuits

- Tap water filtered according to chapter 1.1.9
- Short-circuit tubing for mixing
- Procedural tubing used during procedures
- A measuring cup with at least 500 mL volume
- An approved disinfectant, as listed in the table above

### Materials to drain the water tanks

- 1-2 collection buckets for drained water, each with at least 8 L volume<sup>1</sup>
- Cellulose tissues for removing liquid spills

---

<sup>1</sup> Only required if you will not drain the solution directly into floor drains.

## 6.4.2 Disinfecting the water circuits



### Important

- During the disinfection procedure, leave the used 3T Aerosol Collection Set connected to the heater-cooler.
- Make sure procedural tubing is disconnected from the heater-cooler prior to beginning the disinfection procedure.

### Summary of steps you will complete in this section:

- 1 Prepare for the disinfection procedure
- 2 Drain the water tanks
- 3 Prepare for filling
- 4 Fill the water tanks and add disinfectant
- 5 Prepare for mixing
- 6 Mix the tank contents
- 7 Prepare to run the disinfectant solution through the system
- 8 Run the disinfectant solution through the system
- 9 Drain the disinfectant from the water tanks
- 10 Rinse the tanks and tubing two (2) times
- 11 Replace the aerosol collection set

## 1 Prepare for the disinfection procedure

- ▣ 1 Press the mains power switch to power off the heater-cooler.

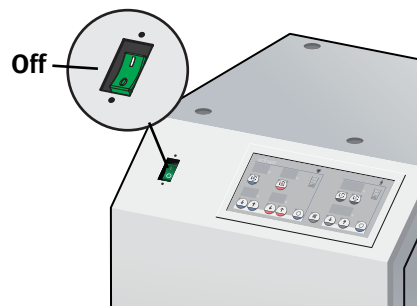

- ▣ 2 Disconnect the aerosol collection canister's vacuum line from the external vacuum source.

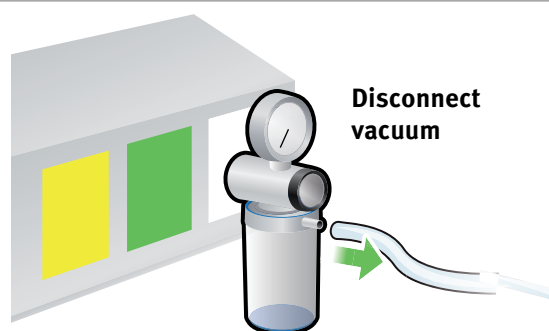

- ▣ 3 Gather the following tubing:
  - Tubing used for mixing (short-circuit tubing)
  - Tubing used during procedures (procedural tubing)

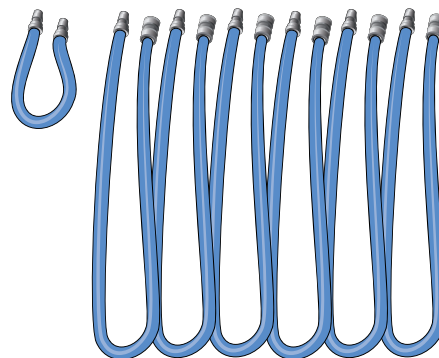

## 2

### Drain the water tanks



#### Important

When draining the water tanks, drain the solution into buckets or directly into floor drains.

- ▣ 1 Twist both drain valve knobs counterclockwise until the drain valves are fully open.
- ▣ 2 Drain the tanks until the solution stops flowing from the drain valves.
- ▣ 3 Twist both drain valve knobs clockwise until the drain valves are fully closed.
- ▣ 4 Dispose of the solution in accordance with your hospital's policies.

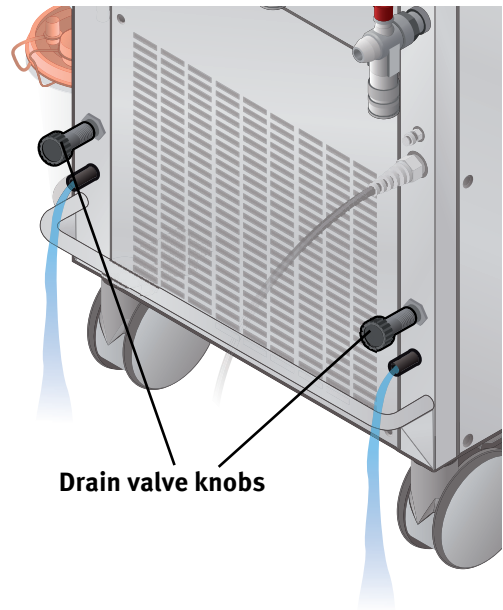

### 3

## Prepare for filling

- ▣ 1 Make sure that both drain valves are fully closed so that water does not flow out when filling the water tanks.

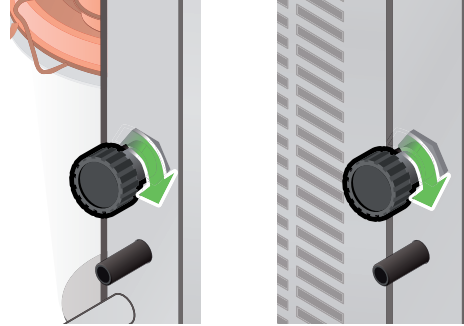

### Important

Make sure to completely drain the water tanks prior to filling with water and disinfectant. Failure to do this can lead to incomplete disinfection of the tanks.

- ▣ 2 Press the mains power switch to power on the heater-cooler.

**NOTE:** A tone will sound indicating that the heater-cooler tanks are empty. You can press the Pause Audio button to pause the tone.

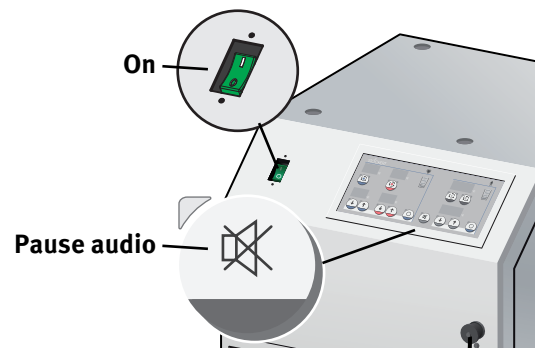

- ▣ 3 Turn the filler neck cap counterclockwise to remove.

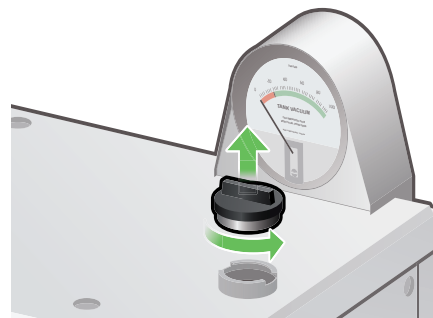

Continue step on next page ▶

- ▣ 4 Apply four sprays of disinfectant on the cap until all surfaces are wet, including the cap's underside and sealing surface.



- ▣ 5 Wait for 5 minutes. Ensure that all surfaces remain wet with disinfectant during this time. Apply additional disinfectant if necessary.

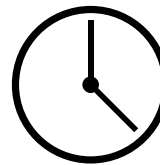

Wait for 5 minutes, then wipe off excess for 2 minutes

Wipe all surfaces with a disinfectant wipe for 2 minutes to remove excess disinfectant.

## 4

### Fill the water tanks and add disinfectant



#### Important

As you pour water into the single filler neck, all three tanks will fill in the following order:

- Cold cardioplegia tank
- Warm cardioplegia tank
- Patient tank

- ▣ 1 Begin filling the water tanks with filtered tap water.

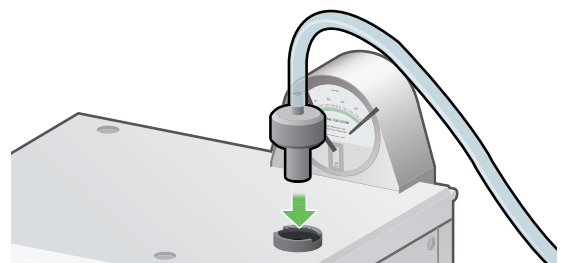

Continue step on next page ▶

- ☑ 2 Pause filling when the **orange segment** on the **patient circuit** water level display lights up.

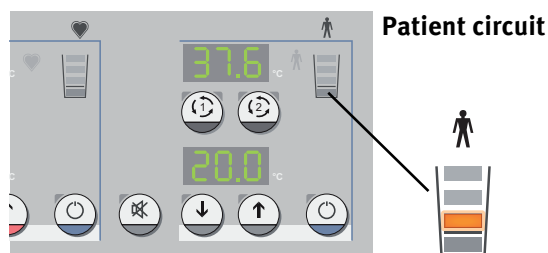

- ☑ 3 Add one disinfectant to the tank contents using the appropriate amount:



### WARNING

**Use only one disinfectant.** The use of both products will potentially result in a dangerous chemical reaction.



### CAUTION

Use of a higher volume of disinfectant might damage the heater-cooler.

- **Option 1: Use 450 mL of Minncare Cold Sterilant.**

Note: This amount of disinfectant mixed with filtered tap water to the second green level of the patient indicator results in a mixture ratio of 1:30.

OR

- **Option 2: Use 180 mL of Clorox Germicidal Bleach (8.25%).**

Note: This amount of disinfectant mixed with filtered tap water to the second green level of the patient indicator results in a mixture ratio of 1:77.

Continue step on next page





- ▣ 4 Continue filling the tanks with filtered tap water until the **second green segment** of the **patient circuit** water level display lights up.

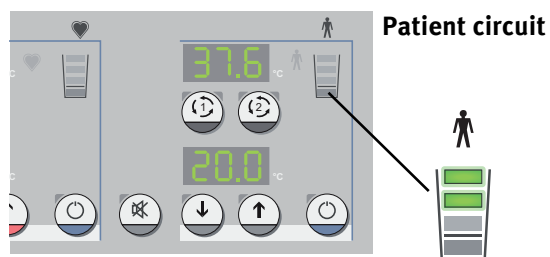

- ▣ 5 Attach the filler neck cap, and turn clockwise to secure.

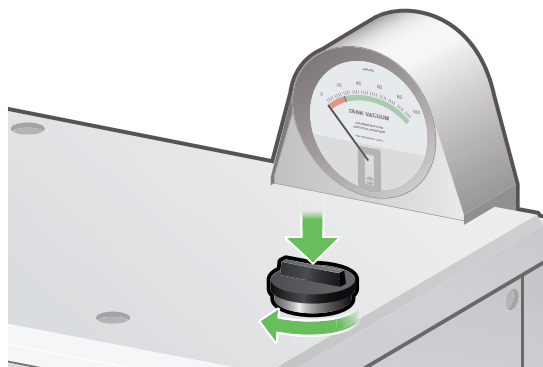

## 5

### Prepare for mixing

- ▣ 1 On the back of the heater-cooler, make sure that the three red valve levers are closed. Turn clockwise to close.
- ▣ 2 Disinfect the heater-cooler connectors and short-circuit tubing fittings.

#### Close valves

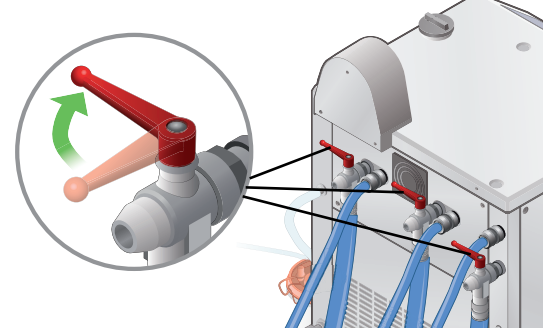

#### Important

Disinfect connectors and fittings every time you make a connection according to chapter 6.3.2 and chapter 6.3.3.

Continue step on next page ▶

- 3 Connect the short-circuit tubing between the cardioplegia circuit inlet and the patient 1 circuit inlet.

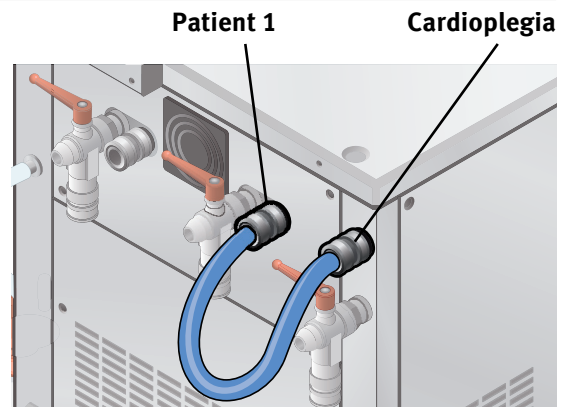

- 4 To avoid triggering a high temperature warning while mixing:

Set the **cold cardioplegia** circuit to 10 °C.

Set the **warm cardioplegia** circuit to 20 °C.

Set the patient circuit to 20.0 °C.

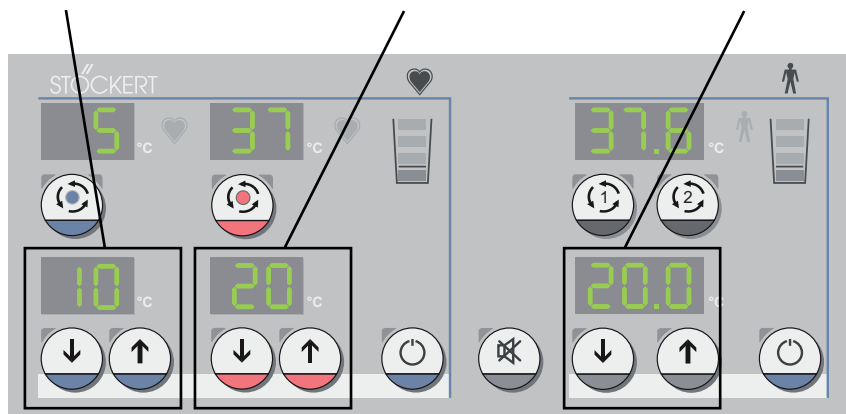

## 6

### Mix the tank contents

- 1 Press the **cold cardioplegia** circuit Start/Stop button to start mixing.

**NOTE:** The green LEDs will flash alternately to indicate the circuit is running.

Press **cold cardioplegia** to start

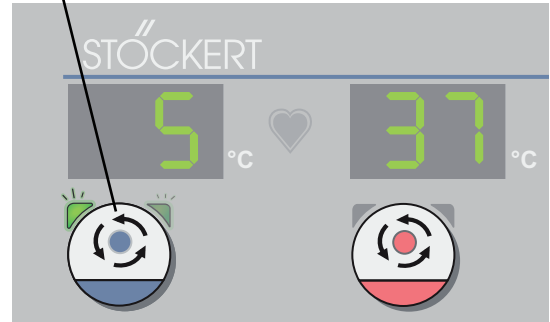

- 2 After 5 minutes, press the **cold cardioplegia** circuit Start/Stop button again to stop mixing.

The mixing process is now complete.

After 5 minutes, press to stop

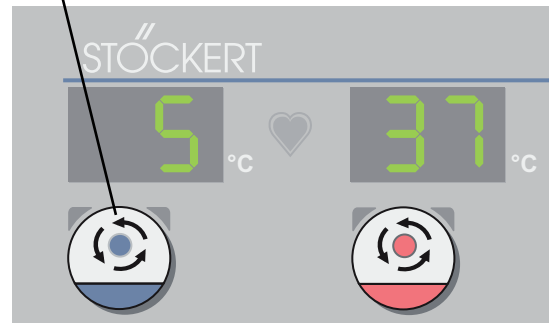

#### CAUTION

Mixing for more than 6 minutes might damage the heater-cooler.

## 7

### Prepare to run the disinfectant solution through the system



#### Important

**All circuits, including those not used during procedures, must be connected to tubing in order to disinfect the system:**

- Make sure to connect procedural tubing to any circuits that are used during procedures.
- If any circuits are not used during procedures, connect these circuits using short-circuit tubing.

- 1 Disconnect the short-circuit tubing between the cardioplegia circuit inlet and the patient 1 circuit inlet.

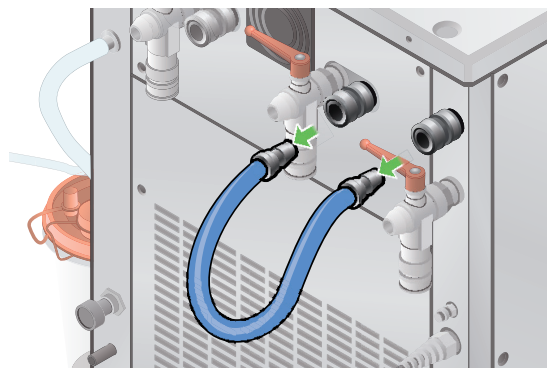

- 2 Disinfect all procedural tubing connectors and suitable short-circuit connectors (part number 73-300-160).



#### Important

Disinfect the connectors and fittings every time you make a connection according to chapter 6.3.2 and chapter 6.3.3.

Continue step on next page



- ▣ 3 Connect the procedural tubing between the circuits using the suitable short-circuit connectors:
- Cardioplegia circuit's inlet and outlet
  - Patient 1 circuit's inlet and outlet
  - Patient 2 circuit's inlet and outlet

**NOTE:** If needed, bridge any circuits not used in procedures with short-circuit tubing.

**Connect tubing**

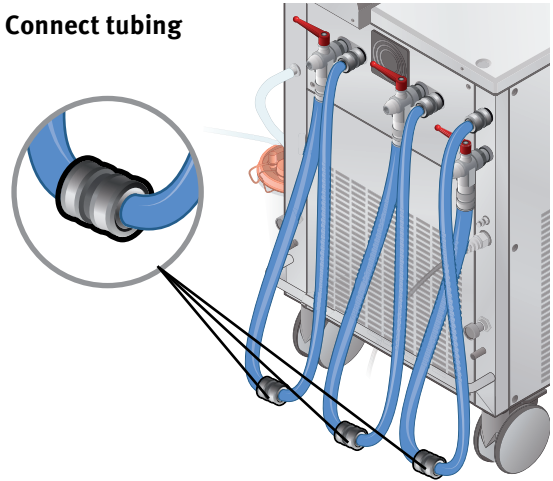

- ▣ 4 On the back of the heater-cooler, turn the three red levers counterclockwise to open the valves.

**Open valves**

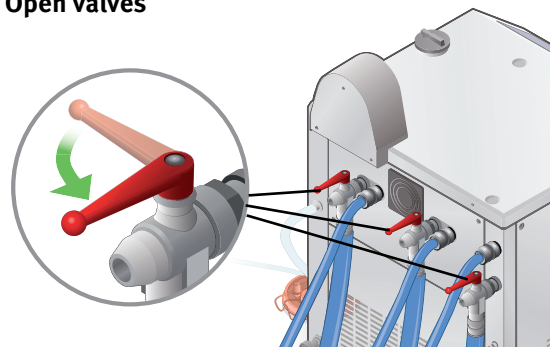

## 8

### Run the disinfectant solution through the system

- 1 Start running the circuit pumps:

Press the **warm cardioplegia** circuit Start/Stop button.

Press the patient 1 and patient 2 circuit Start/Stop buttons.

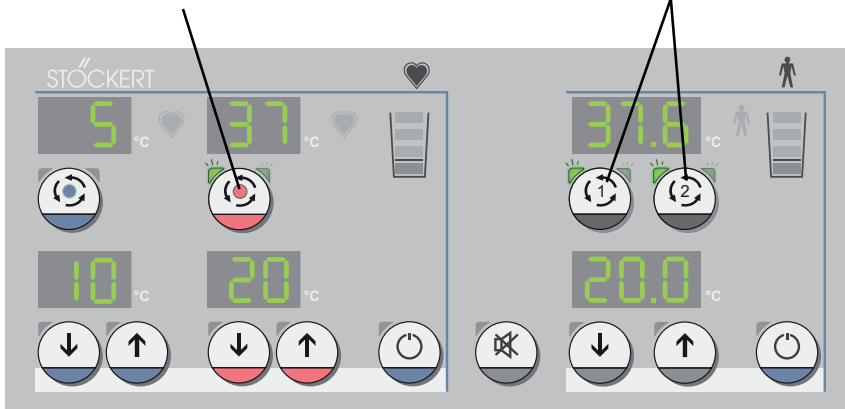

The green circuit button LEDs will flash alternately to indicate the circuit is running.

- 2 Monitor the water level displays.

If the **orange** segment on either water level display flashes, add the specified amount of filtered tap water premixed with one of the following disinfectants:



#### WARNING

**Use only one disinfectant and make sure it is the same one you added when filling the tanks for disinfection.** The use of both products will potentially result in a dangerous chemical reaction.

- **Option 1: Premix 930 mL of filtered tap water** with 30 mL of Minncare Cold Sterilant.

OR

- **Option 2: Premix 1,150 mL of filtered tap water** with 15 mL of Clorox Germicidal Bleach (8.25%).

Continue step on next page



- ▣ 3 After 10 minutes, turn the three red valve levers clockwise to close the valves. Allow the circuit pumps to run until the tubing is drained.

**Close valves**

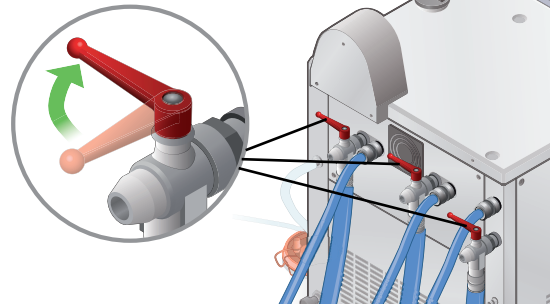

**CAUTION**

Running the circuit pumps with disinfectant solution for more than 11 minutes might damage the heater-cooler.

- ▣ 4 Stop running the circuit pumps:
- Press the **warm cardioplegia** circuit Start/Stop button
  - Press the patient 1 and patient 2 circuit Start/Stop buttons.

The green circuit button LEDs will go out when circuit pumps stop running.

**Press warm cardioplegia**

**Press patient 1, patient 2**

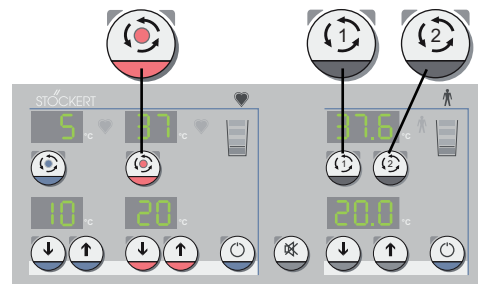

## 9

### Drain the disinfectant from the water tanks



#### Important

When draining the water tanks, drain the solution into buckets or directly into floor drains.

- ▣ 1 Twist both drain valve knobs counterclockwise until the drain valves are fully open.
- ▣ 2 Drain the tanks until the solution stops flowing from the drain valves.
- ▣ 3 Twist both drain valve knobs clockwise until the drain valves are fully closed.
- ▣ 4 Dispose of the solution in accordance with your hospital's policies.

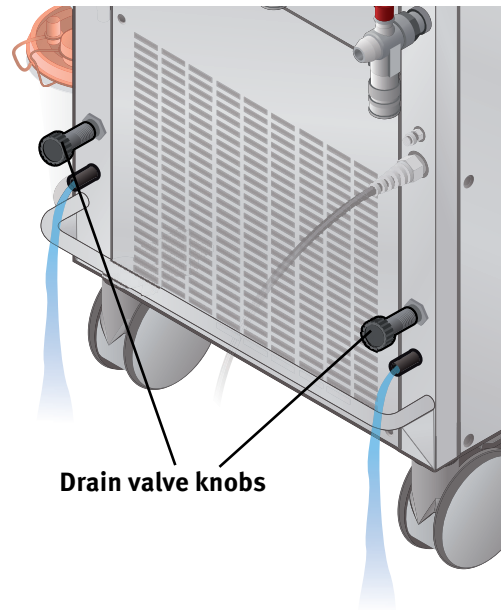



## 10 Rinse the tanks and tubing two (2) times

### CAUTION

To remove residual disinfectant solution from the system, rinse the tanks and tubing after every disinfection cycle two (2) times as described below.

- 1 Make sure that both drain valves are fully closed so that water does not flow out when filling the water tanks.

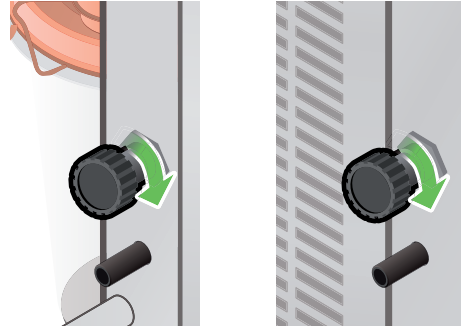

- 2 Using filtered tap water, fill the water tanks until the **second green segment** on the patient circuit water level display lights up.

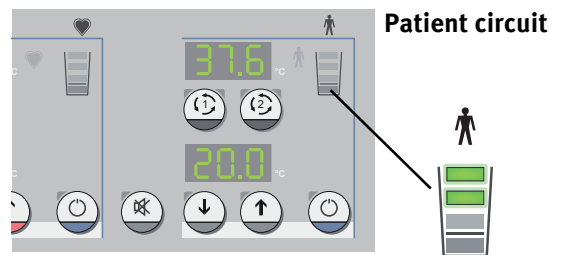

- 3 On the back of the heater-cooler, turn the three red levers counterclockwise to open the valves.

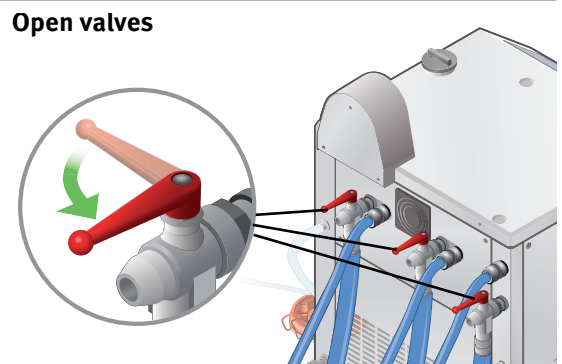

Continue step on next page ▶

- ▣ 4 Start running the circuit pumps:
  - Press the **warm cardioplegia** circuit Start/Stop button
  - Press the patient 1 and patient 2 circuit Start/Stop buttons.

The green circuit button LEDs will flash alternately to indicate the circuit is running.

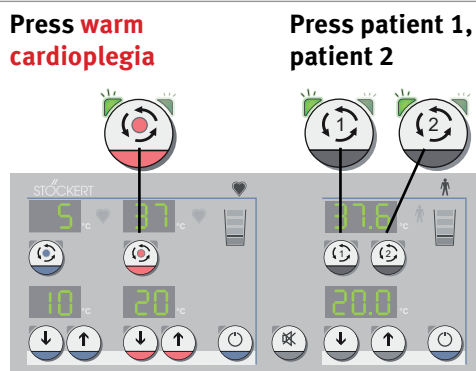

- ▣ 5 After 3 minutes, turn the three red valve levers clockwise to close the valves. Allow the circuit pumps to run until the tubing is drained.

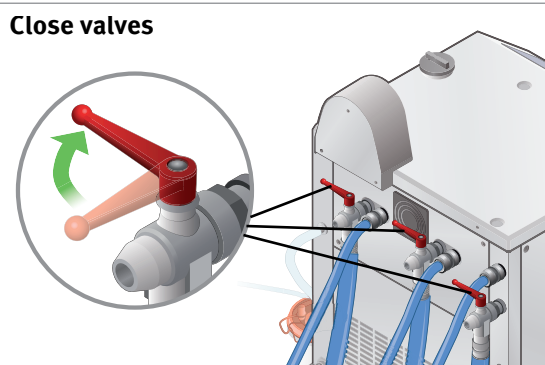

- ▣ 6 Stop running the circuit pumps:
  - Press the **warm cardioplegia** circuit Start/Stop button
  - Press the patient 1 and patient 2 circuit Start/Stop buttons.

The green circuit button LEDs will go out when circuit pumps stop running.

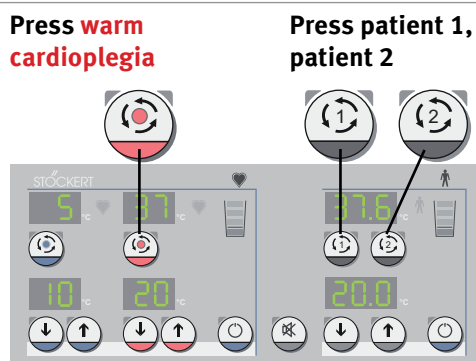

Continue step on next page ▶



### Important

When draining the water tanks, drain the solution into buckets or directly into floor drains.

- ▣ 7 Twist both drain valve knobs counterclockwise until the drain valves are fully open.
- ▣ 8 Drain the tanks until the solution stops flowing from the drain valves.
- ▣ 9 Twist both drain valve knobs clockwise until the drain valves are fully closed.
- ▣ 10 Dispose of the solution in accordance with your hospital's policies.

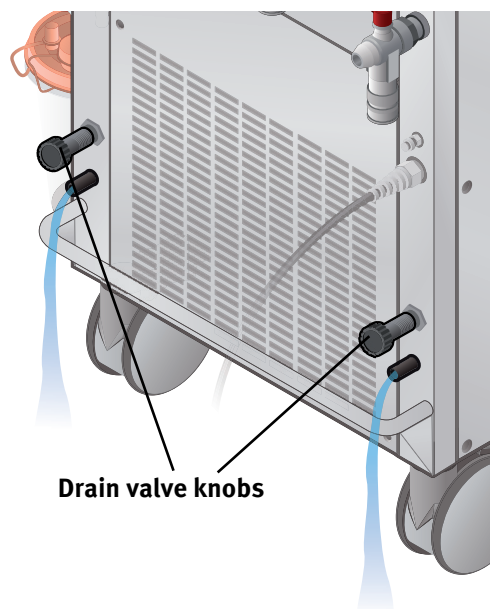

- ▣ 11 Repeat sub steps ▣ 1 through ▣ 10 (Step 10, “Rinse the tanks and tubing two (2) times”) so that the system is rinsed two (2) times.



### CAUTION

Rinsing two (2) times helps to ensure the system is rinsed of disinfectant solution.

## 11 Replace the aerosol collection set

- ▣ Replace the aerosol collection set according to chapter 5.7.2.

The disinfection procedure is now complete. The heater-cooler may now be prepared for a procedure (see chapter 4) or placed in storage (see chapter 6.7).

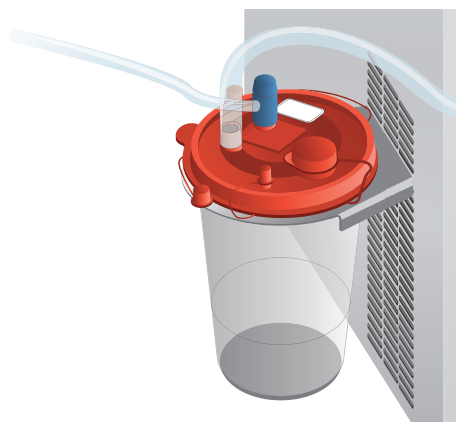

## 6.5 Monitoring the tank water

### 6.5.1 Monitoring the hydrogen peroxide concentration daily

#### Hydrogen peroxide monitoring schedule

- Check hydrogen peroxide concentration daily, before heater-cooler use.
- Check daily, even if the heater-cooler is not in use.



#### Important

- Do not disinfect the drain valve prior to monitoring the hydrogen peroxide concentration because the disinfectant chemical may affect the test results.
- If you do not wish to monitor the hydrogen peroxide concentration daily when the heater-cooler is not in use, drain the water tanks before storing.
- In addition to the instructions in this chapter, refer to your hydrogen peroxide test strips for specific use instructions.
- Follow your hospital's policies regarding the use of personal protective equipment (PPE).

#### Materials you will need:

- Empty container with at least 100 mL volume
- Sterile sample container with at least 5 mL volume
- Hydrogen peroxide (H<sub>2</sub>O<sub>2</sub>) test strips (MQuant, Peroxide Test, Method: colorimetric with test strips, 100 - 1,000 mg/l H<sub>2</sub>O<sub>2</sub>, Reference 1.10337.0001, or equivalent)

## Summary of steps you will complete in this section:

- 1 **Collect a sample**
- 2 **Interpret the hydrogen peroxide concentration**
- 3 **Take action based on the hydrogen peroxide concentration**
- 4 **Make sure the water tanks are full**

# 1

## Collect a sample

- ▣ 1 Twist the patient circuit drain valve knob counterclockwise to open the patient circuit drain valve.
- ▣ 2 Drain at least 100 mL of solution from the drain valve and discard.

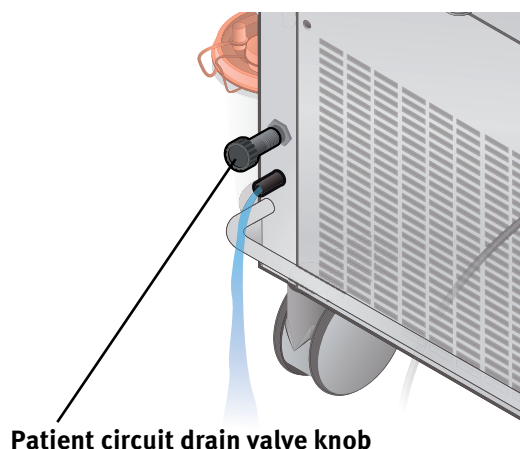

- ▣ 3 Before closing the drain valve, drain at least 5 mL of solution into the sterile sample container.

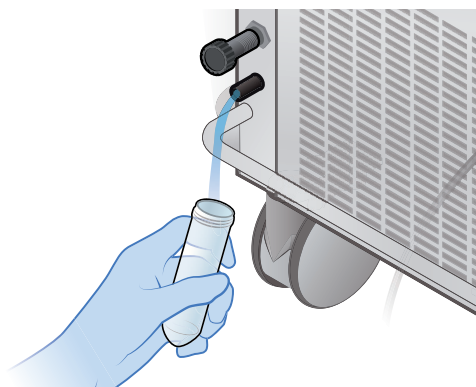

- ▣ 4 Twist the patient circuit drain valve knob clockwise until the drain valve is fully closed.



### Important

The patient circuit water level might be low. Do not add volume to the tanks until you complete the hydrogen peroxide test and adjustment procedures.

## 2

### Interpret the hydrogen peroxide concentration

- ▣ 1 Immerse the test strip in the sample container for the time specified in the test strip instructions.

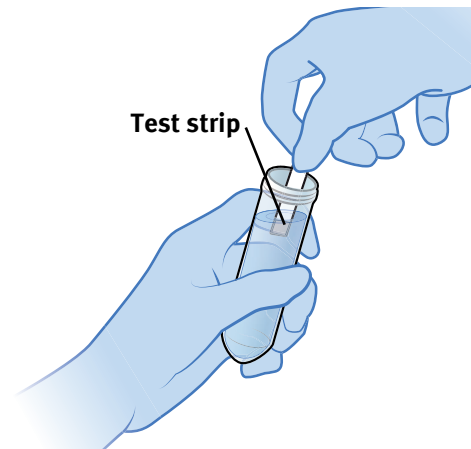

- ▣ 2 Then, remove the strip and shake any excess liquid from the test strip.

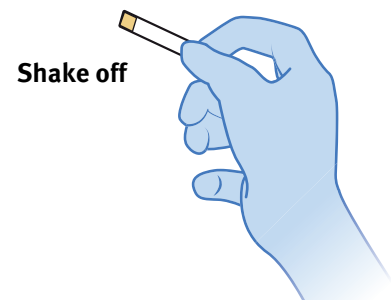

- ▣ 3 Determine the hydrogen peroxide concentration using the color key supplied with your test strips.
- ▣ 4 Document the hydrogen peroxide concentration according to your hospital's policies.
- ▣ 5 Determine whether the hydrogen peroxide concentration is acceptable and take action as described in the next step.

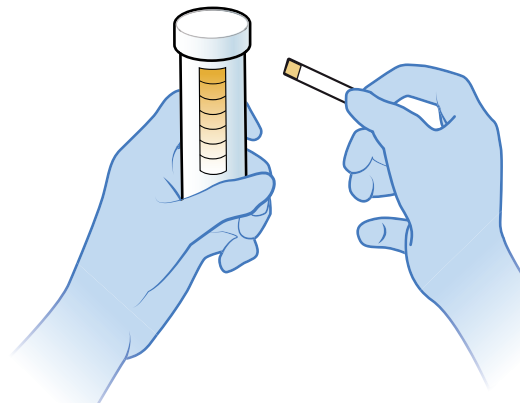



### 3

## Take action based on the hydrogen peroxide concentration

**Acceptable concentration:**  
greater than or equal to 100 mg/L H<sub>2</sub>O<sub>2</sub>

There is no additional action to be taken other than to monitor the concentration daily.

**Unacceptable concentration:**  
less than 100 mg/L H<sub>2</sub>O<sub>2</sub>

Adjust hydrogen peroxide concentration according to adjustment steps below:

- ☑ 1 Make sure the circuit valves are closed, and any connected tubing is drained.

**Close valves**

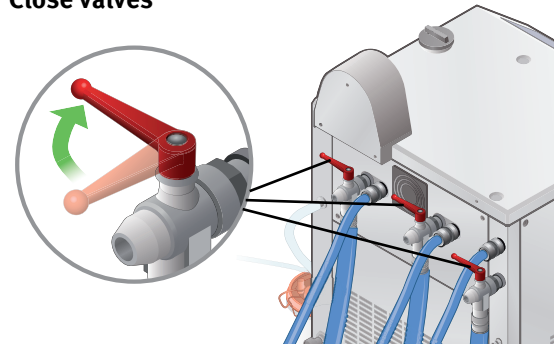

- ☑ 2 Turn the filler neck cap counterclockwise to remove.

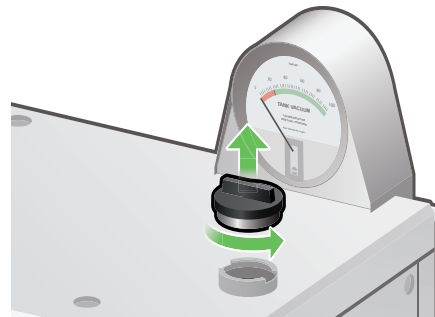

- ☑ 3 Apply four sprays of disinfectant on the cap until all surfaces are wet, including the cap's underside and sealing surface.



Continue step on next page ▶

**(Continued)**

**Unacceptable concentration: less than 100 mg/L H<sub>2</sub>O<sub>2</sub>**

- ▣ 4 Wait for 5 minutes. Ensure that all surfaces remain wet with disinfectant during this time. Apply additional disinfectant if necessary.

Wipe all surfaces with a disinfectant wipe for 2 minutes to remove excess disinfectant.

**NOTE:** You may proceed to the next step during the disinfectant's exposure time.

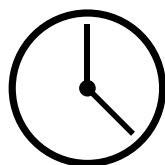

Wait for 5 minutes, then wipe off excess for 2 minutes

- ▣ 5 Pour 100 mL of medical grade 3% hydrogen peroxide into the tank.

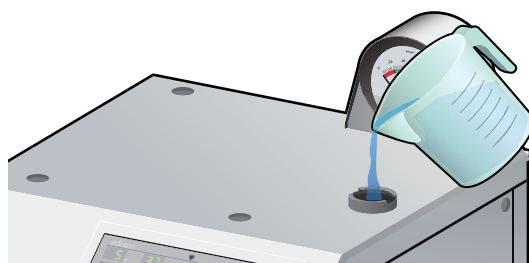

- ▣ 6 Attach the filler neck cap and turn clockwise to secure.

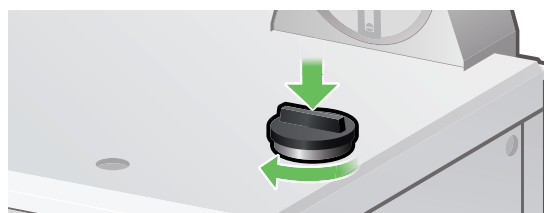

- ▣ 7 After adjusting the hydrogen peroxide concentration, mix the heater-cooler's solution:

- Attach short-circuit tubing between patient 1 inlet and cardioplegia inlet.
- Run cold cardioplegia pump for 5 minutes.
- Disconnect short-circuit tubing.

(See chapter 6.6 steps 4 and 5 for complete instructions on mixing).

**The H<sub>2</sub>O<sub>2</sub> adjustment procedure is now complete.**



5 min



## 4

### Make sure the water tanks are full



#### Important

Do not add volume to the tanks until you complete the hydrogen peroxide test and adjustment procedures.

- ▣ 1 Determine if the water tank volume is acceptable by checking both circuit's water level displays.
  - If the second green segments on both displays are illuminated, the volume is acceptable, and no action is needed.
  - If the second green segments on either display are not illuminated, the volume is unacceptable. Add volume to the water tanks. Proceed to Step ▣ 2.

#### Acceptable volume Cardioplegia or patient circuits



#### Unacceptable volume Cardioplegia or patient circuits



- ▣ 2 If you need to add volume to the tanks:
  - Prepare a mixture of hydrogen peroxide and filtered tap water at a ratio of 1:91. For example: 10 mL of hydrogen peroxide and 910 mL of filtered tap water
  - Fill the water tanks with the mixture until the **second green segments** of both circuit water level displays light up.

#### 1:91 mixture hydrogen peroxide to filtered tap water

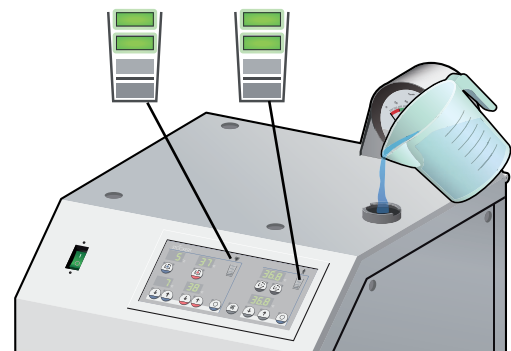

## 6.5.2 Monitoring the water for bacteria and NTM

### Bacteria and NTM monitoring schedule

- At least once a month, monitor the tanks' water for bacteria and NTM.
- When you monitor the tanks for bacteria and NTM, do so when you are disinfecting the system. Take water samples before and after the disinfection procedures.



### Important

- Samples can be stored in a refrigerator at temperatures from 2 °C to 8 °C. Do not store samples for more than 24 hours.
- Pay attention to hand hygiene and protective barriers by disinfecting your hands and using gloves.

### Materials you will need:

- Sterile containers for bacteria sampling: 2x 50 mL
- Sterile containers for NTM sampling: 2x 50 mL or 1x 100 mL
- Disinfectant spray and/or wipes
- 1-2 collection buckets for drained water, each with at least 1 L volume.  
**NOTE:** You may drain the solution into the collection buckets or directly into floor drains.
- Supplies to identify and track samples based on your hospital's policies (e.g., sample labels and permanent markers)

### Summary of steps you will complete in this section:

1

Prepare to collect a water sample

2

Collect the sample

3

Disinfect the heater-cooler, then collect a second set of samples

4

Interpret the results

# 1

## Prepare to collect a water sample

- ▣ 1 Label the samples with the serial number or internal identification number of the heater-cooler based on your hospital's policies.

Serial number location

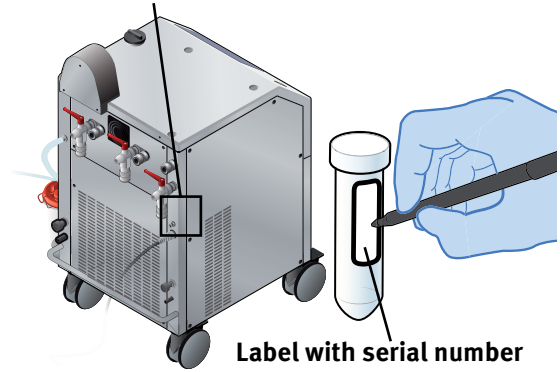

- ▣ 2 Disconnect any tubing connected to the patient drain.

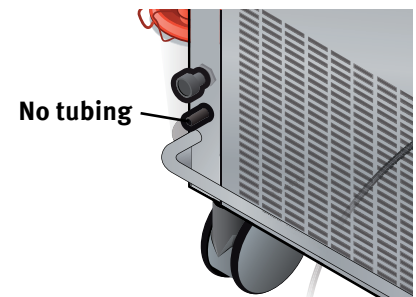

- ▣ 3 Spray disinfectant on the patient circuit drain and patient circuit drain valve until wet, including the opening of the drain.

Wait for the exposure time specified by the disinfectant you are using.

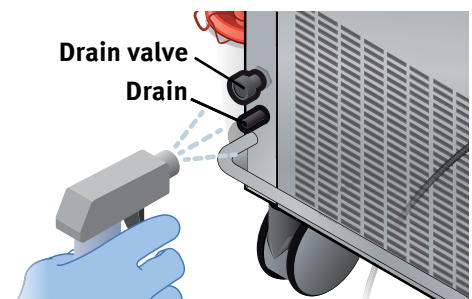

Continue step on next page ▶

- ▣ 4 Disinfect the procedural tubing connectors and a suitable short-circuit connector (part number 73-300-160).



**Important**

Disinfect the connectors and fittings every time you make a connection according to chapter 6.3.2 and chapter 6.3.3.

- ▣ 5 Connect the procedural tubing between the circuits using the short-circuit connector.

**Connect tubing**

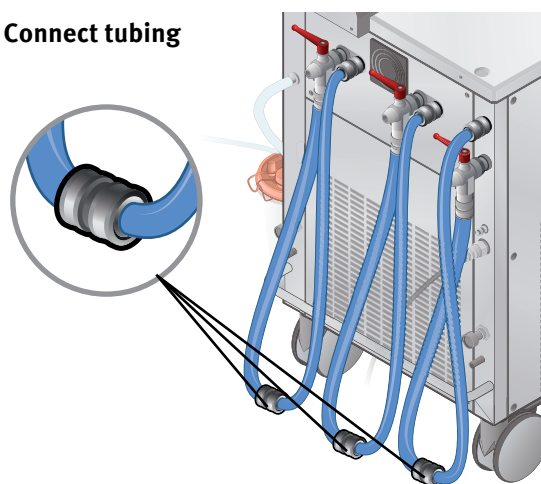

**Important**

**Do not** connect tubing to any circuits not used during procedures.

- ▣ 6 On the back of the heater-cooler, for any circuits with tubing connected, turn the red levers counterclockwise to open the valves.

**Open valves connected to tubing**

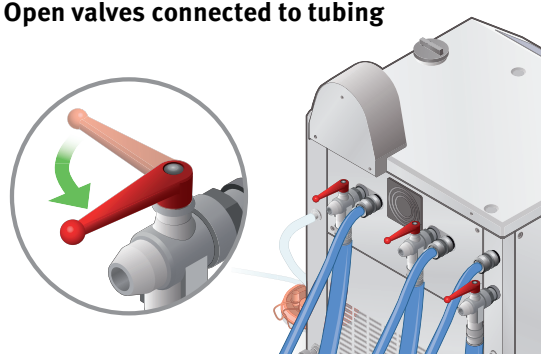

Continue step on next page ▶

- ▣ 7 If the heater-cooler is powered off, press the mains power switch to power on the heater-cooler.

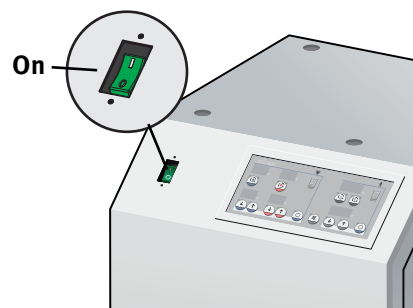

- ▣ 8 Start running the circuit pumps:
  - Press the **warm cardioplegia** circuit Start/Stop button
  - Press the patient 1 and patient 2 circuit Start/Stop buttons.

**NOTE:** Run all three circuits even if tubing is not connected.

Press **warm cardioplegia**

Press **patient 1, patient 2**

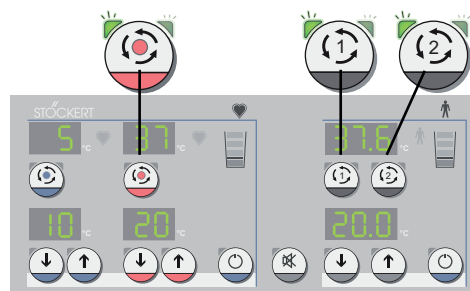

- ▣ 9 After 5 minutes, turn the red valve levers clockwise to close the valves. Allow the circuit pumps to run until the tubing is drained.

Close valves

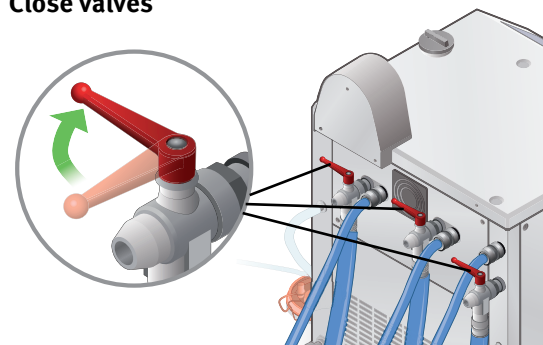

- ▣ 10 Stop running the circuit pumps:
  - Press the **warm cardioplegia** circuit Start/Stop button
  - Press the patient 1 and patient 2 circuit Start/Stop buttons.

Press **warm cardioplegia**

Press **patient 1, patient 2**

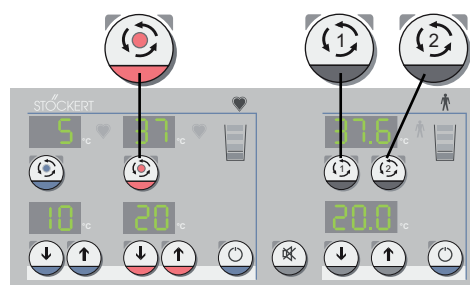

## 2

### Collect the sample

- ☑ 1 Check to make sure the disinfectant is completely dry. Do not take water samples until the disinfectant has completely dried.

Make sure valve is dry

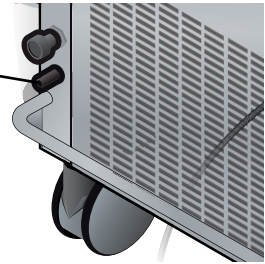

#### Important

When draining the water tank, drain the solution into buckets or directly into floor drains.

- ☑ 2 Twist the patient circuit drain valve knob counter clockwise to fully open the patient circuit drain valve.
- ☑ 3 Drain the solution for **at least 5 seconds** and discard.

Patient circuit drain valve knob

Drain 500 mL

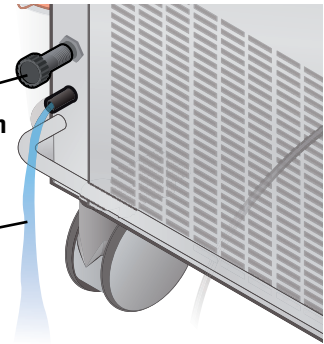

- ☑ 4 Keeping the lid of the sample container away from non-sterile surfaces, remove the lid from the sample container.

**Do not** place the lid on a non-sterile surface.

**Do not** touch the upper rim of the sample container.

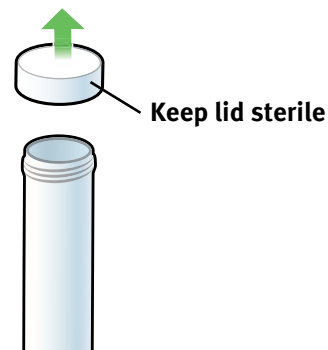

Continue step on next page ▶



- ☑ 5 Before closing the drain valve, fill each sample container needed for the test you are running.
  - **Bacteria check, every month:**  
Fill one 50 mL container.
  - **NTM check, every month:**  
Fill two 50 mL containers, or one 100 mL container.

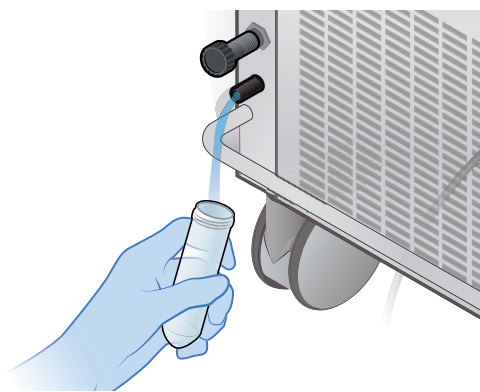

- ☑ 6 Secure the lid on each container.

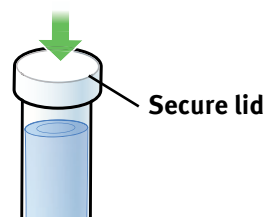

- ☑ 7 Twist the patient circuit drain valve knob clockwise until the drain valve is fully closed.

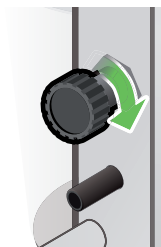

### 3

## Disinfect the heater-cooler, then collect a second set of samples

- ☑ 1 Disinfect the water circuits according to chapter 6.4.2.
- ☑ 2 Repeat this monitoring procedure (steps 1 and 2) to collect sample(s) after water circuit disinfection.



### Important

If the water samples cannot be immediately forwarded to the testing laboratory, store the samples in a refrigerator at 2 °C to 8 °C for up to 24 hours.

Potential contract laboratory resources: Nelson Labs, NAMSA, MICROBAC, Toxikon, Microchem Laboratory, Eurofins Scientific.

## 4

### Interpret the results

#### Bacteria results

Determine whether the bacteria count is acceptable and take action as described below:

#### Acceptable bacteria count:

##### Less than 100 CFU/mL

There is no additional action to be taken other than to monitor the bacteria count monthly.

#### Unacceptable bacteria count:

##### Greater than or equal to 100 CFU/mL

**System may not be used.** Remove the system from service and analyze to determine possible causes.

Contact your hygiene officer and your authorized service technician.

Continue step on next page



## NTM results

Determine whether the NTM count is acceptable and take action as described below:

### Acceptable NTM count:

#### Less than 1 CFU/100 mL

There is no additional action to be taken other than to monitor the bacteria count monthly.

### Unacceptable NTM count:

#### Greater than 1 CFU/100 mL

**System may not be used.** Remove the system from service and analyze to determine possible causes.

Contact your hygiene officer and your authorized service technician.

## 6.6 Changing the water and adding hydrogen peroxide

### Water change schedule:

- At least once a week



### Important

- Follow your hospital's policies regarding the use of personal protective equipment (PPE).
- Do not use de-ionized or reverse osmosis processed water. This water can cause deterioration of the refrigeration system.
- Change the water in the heater-cooler at least once a week, whether the heater-cooler is used or not.

### Materials you will need

- Tap water filtered according to chapter 1.1.9.
- 1-2 collection buckets for drained water, each with at least 8 L volume.  
**NOTE:** Only required if you will not drain the solution directly into floor drains.
- At least 150 mL of medical grade 3% hydrogen peroxide solution that is not expired.
- A measuring cup with at least 150 mL volume for hydrogen peroxide.

### Summary of steps you will complete in this section:

---

**1** Drain the water tanks

---

**2** Prepare for filling

---

**3** Fill the water tanks

---

**4** Prepare for mixing

---

**5** Mix the tank contents

## 1 Drain the water tanks



### Important

When draining the water tanks, drain the solution into buckets or directly into floor drains.

- ▣ 1 Twist both drain valve knobs counterclockwise until the drain valves are fully open.
- ▣ 2 Drain the tanks until the solution stops flowing from the drain valves.
- ▣ 3 Twist both drain valve knobs clockwise until the drain valves are fully closed.
- ▣ 4 Dispose of the solution in accordance with your hospital's policies.

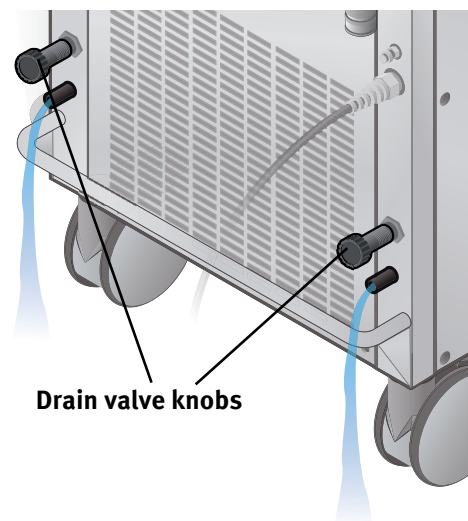

## 2 Prepare for filling

- ▣ 1 Make sure that the aerosol collection canister is empty. Refer to chapter 5.7.2 for instructions on emptying the aerosol collection canister.

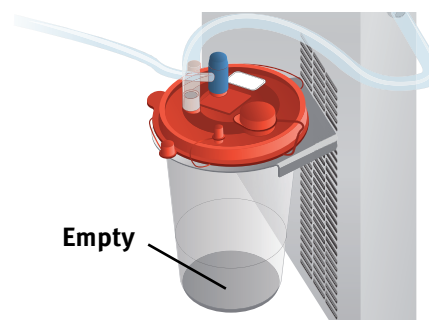

Continue step on next page ▶

- 2 Make sure that both drain valves are fully closed so that water does not flow out when filling the water tanks.



- 3 Press the mains power switch to power on the heater-cooler.

**NOTE:** A tone will sound indicating that the heater-cooler tanks are empty. You can press the Pause Audio button to pause the tone.

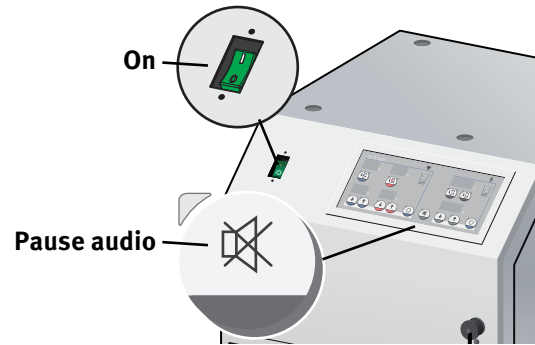

- 4 Turn the filler neck cap counterclockwise to remove.

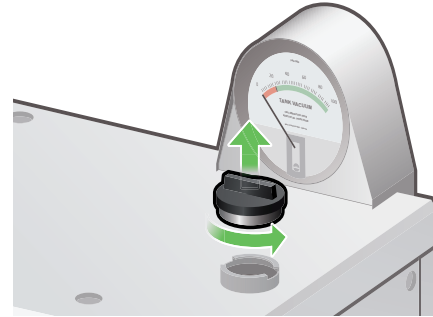

- 5 Apply four sprays of disinfectant on the cap until all surfaces are wet, including the cap's underside and sealing surface.
- 6 Wait for 5 minutes. Ensure that all surfaces remain wet with disinfectant during this time. Apply additional disinfectant if necessary.

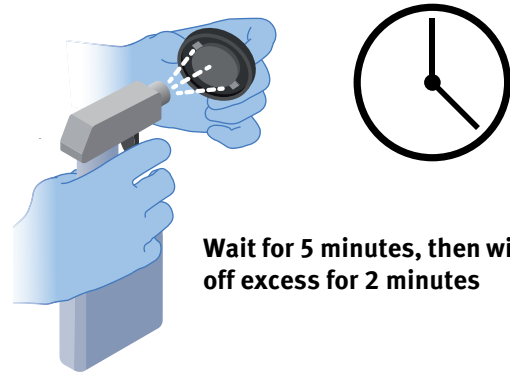

**Wait for 5 minutes, then wipe off excess for 2 minutes**

Wipe all surfaces with a disinfectant wipe for 2 minutes to remove excess disinfectant.

### 3 Fill the water tanks



#### Important

As you pour water into the single filler neck, all three tanks will fill in the following order:

- Cold cardioplegia tank
- Warm cardioplegia tank
- Patient tank

- ▣ 1 Begin filling the water tanks with **filtered tap water**.

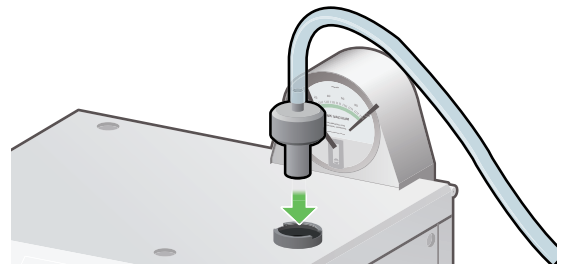

- ▣ 2 Pause filling when the **orange segment** on the **patient circuit** water level display lights up.

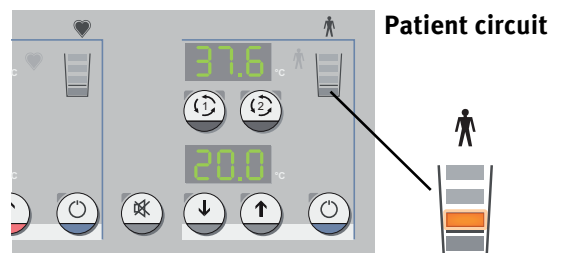

- ▣ 3 Pour 150 mL of medical grade 3% hydrogen peroxide solution into the tank.

**150 mL hydrogen peroxide**

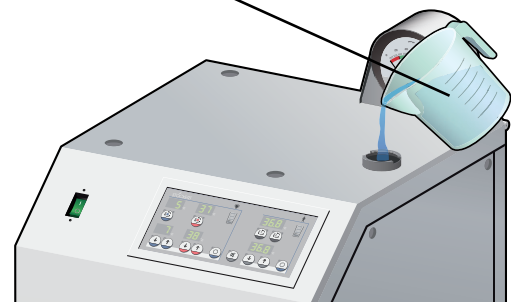

Continue step on next page ▶

- 4 Continue filling the tanks with filtered tap water until the **second green segment** of the **patient circuit** water level display lights up.

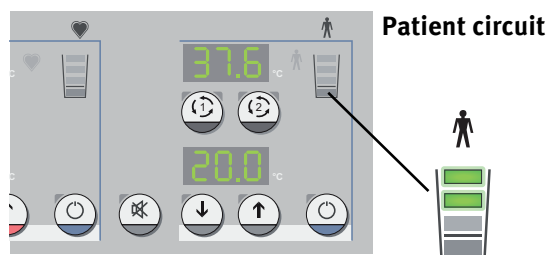

- 5 Attach the filler neck cap, and turn clockwise to secure.

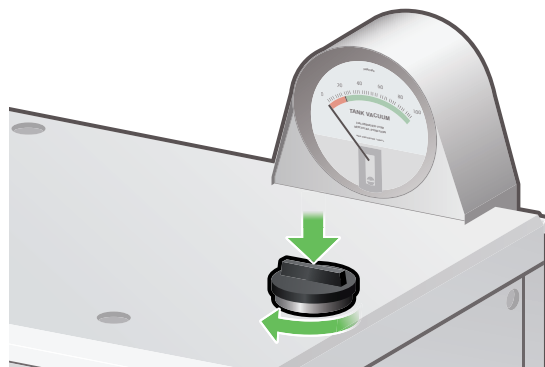

## 4

### Prepare for mixing

- 1 On the back of the heater-cooler, make sure that the three red valve levers are closed. Turn clockwise to close.

Close all valves

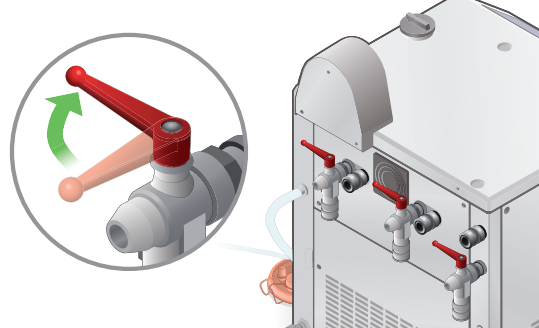

Continue step on next page ▶



- ▣ 2 Apply four sprays of disinfectant on the short-circuit tubing's male connectors until all surfaces are wet.
- ▣ 3 Wait for 5 minutes. Ensure that all surfaces remain wet with disinfectant during this time. Apply additional disinfectant if necessary.

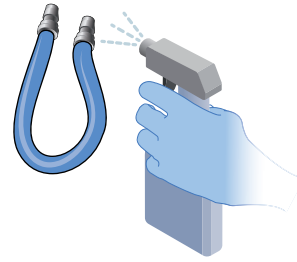

### Important

Make sure that no liquids enter the housing of the heater-cooler when spraying disinfectant.

- ▣ 4 Conduct steps ▣ 5 and ▣ 7 on these tubing connectors:
  - **Patient 1** inlet connector
  - **Cardioplegia** inlet connector

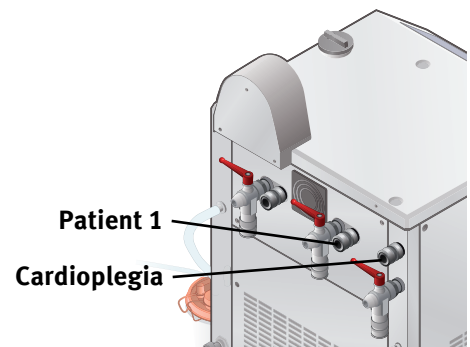

- ▣ 5 Apply four sprays of disinfectant on the exterior of the female connector. Push and hold the quick release ring back and apply four sprays of disinfectant to the interior of each connector.

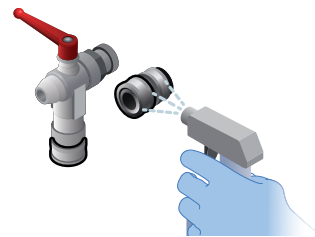

- ▣ 6 Wait for 5 minutes. Ensure that all surfaces remain wet with disinfectant during this time. Apply additional disinfectant if necessary.

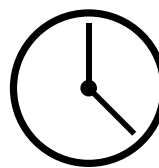

Wait for 5 minutes, then wipe off excess for 2 minutes

Wipe all surfaces with a disinfectant wipe for 2 minutes to remove excess disinfectant.

Continue step on next page ▶

- 7 Connect the short-circuit tubing between the cardioplegia circuit inlet and the patient 1 circuit inlet.

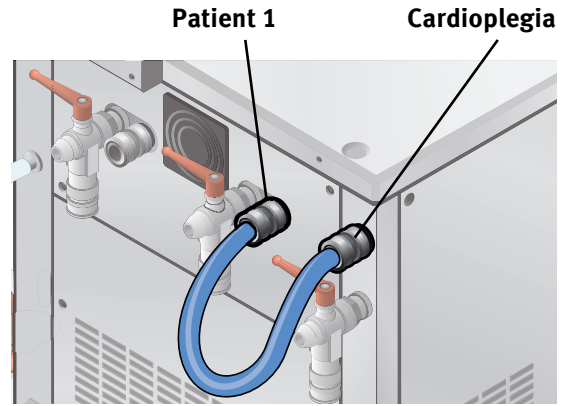

- 8 To avoid triggering a high temperature warning while mixing:

Set the **cold cardioplegia** circuit to 10 °C.

Set the **warm cardioplegia** circuit to 20 °C.

Set the patient circuit to 20.0 °C.

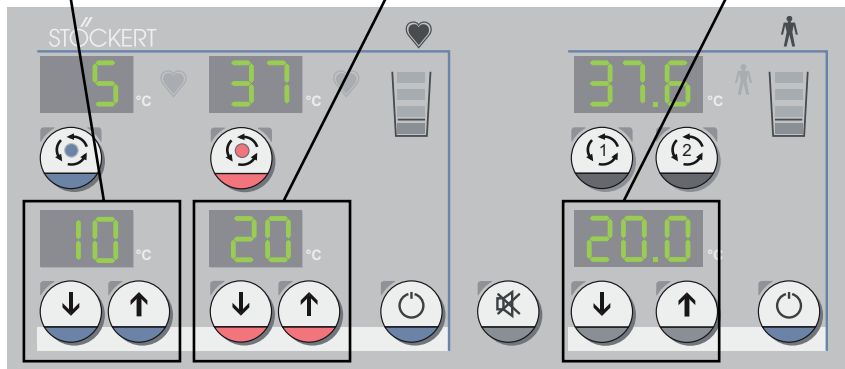

## 5 Mix the tank contents

- 1 Press the **cold cardioplegia** circuit Start/Stop button to start mixing.

**NOTE:** The green LEDs will flash alternately to indicate the circuit is running.

Press **cold cardioplegia** to start

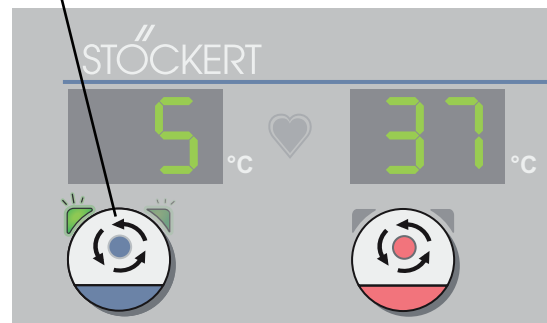

Continue step on next page ▶

- 2 After 5 minutes, press the **cold cardioplegia** circuit Start/Stop button again to stop mixing.

After 5 minutes, press to stop

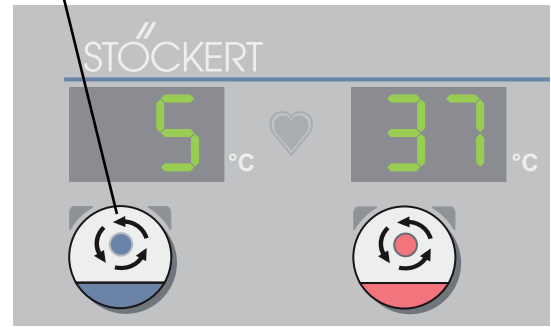

- 3 Disconnect the short-circuit tubing between the cardioplegia circuit inlet and the patient 1 circuit inlet.

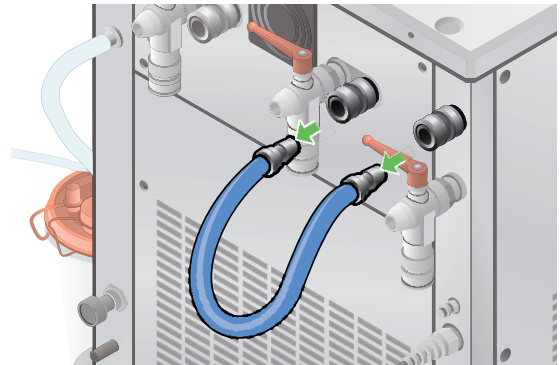

**You can now connect the procedural tubing and use the heater-cooler.**

Refer to chapter 4.3 for instructions on selecting and connecting the tubing.



### **Important**

Check the heater-cooler's hydrogen peroxide concentration daily, even if the heater-cooler is not in use. Daily checks must be performed before heater-cooler use. Refer to chapter 6.5.1 for instructions on checking the hydrogen peroxide concentration.

## 6.7 Preparing the heater-cooler for storage



### Important

Disinfect the heater-cooler every 14 days during storage.

### Summary of steps you will complete in this section:

1 Clean and disinfect the entire system

2 Make sure all tanks are drained

3 Disconnect and store all tubings

### 1

### Clean and disinfect the entire system

- ▣ 1 Clean and disinfect external surfaces, connectors, and fittings according to chapter 6.3.

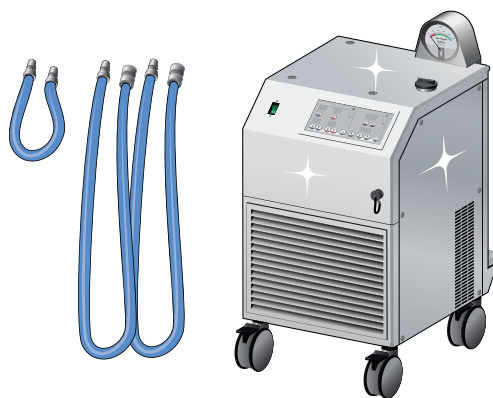

- ▣ 2 Disinfect the water circuits according to chapter 6.4.



## 2 Make sure all tanks are drained



### Important

When draining the water tanks, drain the solution into buckets or directly into floor drains.

- ▣ 1 Twist both drain valve knobs counterclockwise until the drain valves are fully open.
- ▣ 2 Drain the tanks until the solution stops flowing from the drain valves.
- ▣ 3 Twist both drain valve knobs clockwise until the drain valves are fully closed.
- ▣ 4 Dispose of the solution in accordance with your hospital's policies.

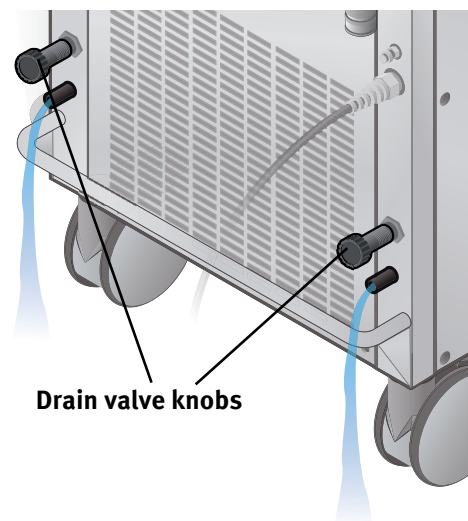

## 3 Disconnect and store all tubings

- ▣ 1 Disconnect all tubings attached to the heater-cooler. This includes:
  - Short-circuit tubing
  - Procedural tubing
  - Aerosol collection set tubing
- ▣ 2 Store all tubings such that:
  - They are in a dry location that is free of dust
  - They are in an orientation that will enable any residual water to drain

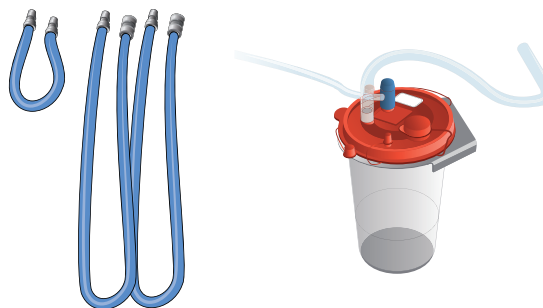

## 6.8 Cleaning the heater-cooler interior



### Important

Clean the interior of your heater-cooler regularly or if the fan behind the front ventilation grill is running too quickly and/or too loudly. Cleaning the interior of the heater-cooler will eliminate any dust that has collected inside the heater-cooler and has inhibited air circulation.

If excessive dirt is present or if the non-accessible interior surfaces require cleaning, contact your authorized service technician.

### Summary of steps you will complete in this section:

- 1 **Disconnect from the power supply**
- 2 **Clean the accessible areas behind the front grill**

## 1 Disconnect from the power supply

- ▣ Disconnect the heater-cooler's power cable from the power supply outlet.

## 2 Clean the accessible areas behind the front grill

- ▣ 1 Unscrew the four screws on the front ventilation grill.
- ▣ 2 Remove the front ventilation grill only. Do not remove the side and rear ventilation panels.
- ▣ 3 Using a vacuum cleaner or pressurized air, clean the accessible areas of the heater-cooler's interior.
- ▣ 4 Reattach the ventilation grill and secure the four screws.

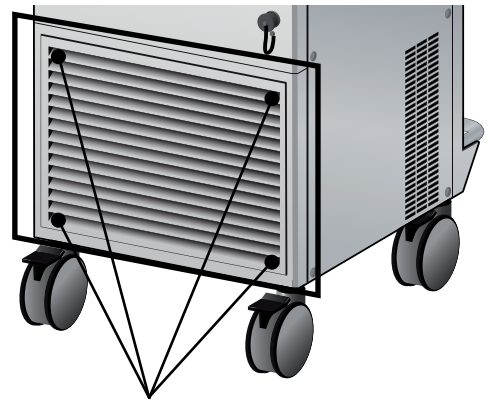

Front grill screw locations

## 6.9 Replacing the tubings once a year

1

### Replace the procedural tubing at least once a year

- ☑ Use only tubing that is approved for use with the heater-cooler (i.e. part number 75-510-218).

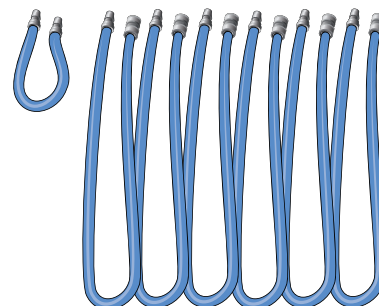



# 7 Technical specifications

**This chapter provides technical specifications including information about the heater-cooler's physical characteristics, labeling, part numbers, accessories, and electromagnetic compatibility. This chapter also includes warranty information.**

# 7.1 Specifications

## 7.1.1 Dimensions and weights

### Heater-cooler

<b>Width</b>	500 mm
<b>Height</b>	975 mm
<b>Depth</b>	680 mm
<b>Weight (when empty)</b>	100 kg
<b>Max. weight of equipped device</b>	125 kg

## 7.1.2 Operating, storage and transport conditions

### Operating conditions

Operating temperature	10 °C through 30 °C Note: Cooling performance might be reduced at operating temperatures greater than 25 °C.
Relative humidity	30% through 75%
Operating altitude (atmospheric pressure)	0 ... 2,000 m (700 hPa ... 1,060 hPa)

### Storage conditions

Storage temperature	-10 °C through 60 °C
Relative humidity	0% through 80%
Atmospheric pressure	500 hPa through 1,060 hPa (7.3 psi through 15.4 psi)

### Transport conditions

Transport temperature	-10 °C through 60 °C
Relative humidity	0% through 85%
Atmospheric pressure	500 hPa through 1,060 hPa (7.3 psi through 15.4 psi)

## 7.1.3 Electrical specifications

### Heater-cooler

<b>Drip-proof</b>	IPX1		
<b>Input current</b>	16 A 13 A for devices with a BS 1363 (type G) mains plug		
<b>Input voltage (variants are device-specific)</b>	Mains Voltage, Nominal (V)	Mains Frequency, Nominal (Hz)	Maximum Current Draw (A)
	120 <sup>1</sup>	60	16
	127	60	16
	200	50	16
	200	60	16
	208 <sup>1</sup>	60	16
	220	50	13 <sup>2</sup> / 16
	220	60	13 <sup>2</sup> / 16
	230	50	13 <sup>2</sup> / 16
	230	60	13 <sup>2</sup> / 16
	240	50	13 <sup>2</sup> / 16
	240	60	13 <sup>2</sup> / 16
<b>Allowed voltage tolerance</b>	± 10% max		
<b>Fuse protection</b>	T6A3 250 V (serviced by authorized service technicians only)		

1 Available in the U.S.

2 Heater-coolers utilizing a BS 1363 (Type G) mains plug are limited to 13 A

## 7.1.4 General performance data

### General data

<b>Heating element performance (2 x patient, 1 x cardioplegia)</b>	3 x 650 W (input voltage 120/127 V ~) 3 x 900 W (input voltage 200 V ~) 3 x 1,000 W (input voltage 200/208 V ~) 3 x 1,150 W (input voltage 220 V ~) 3 x 1,250 W (input voltage 230 V ~) 3 x 1,350 W (input voltage 240 V ~)
<b>Cooling performance</b>	> 1,500 W at an ambient and tank temperature of 20°C
<b>Noise level at 1 m</b>	≤ 63 dB (A)

### Volume and flow

<b>Minimum level patient tank</b>	4.5 L (11.6 L total tank volume)
<b>Maximum level patient tank</b>	6.5 L (13.8 L total tank volume)
<b>Water flow patient circuits</b>	13.0 - 16.4 liters per minute (circuit outlet) 10.8 – 12.6 liters per minute (5 m + 5 m circuit)
<b>Water flow cardioplegia circuit</b>	7.5 – 9.8 liters per minute (circuit outlet) 7.4 – 8.7 liters per minute (5 m + 5 m circuit)
<b>Water pressure in patient circuits</b>	0.63 – 0.79 bar
<b>Water pressure in cardioplegia circuits</b>	0.65 – 0.72 bar

### Temperature ranges

<b>Normal range patient circuits</b>	2.0 °C through 41.0 °C ± 0.5 °C
<b>Normal range cool cardioplegia circuit</b>	2 °C through 10 °C ± 2 °C
<b>Normal range warm cardioplegia circuit</b>	15 °C through 41 °C ± 1 °C

## Cleaning and disinfection process

<p><b>Disinfection Effectiveness</b></p> <p>Devices were inoculated with at least <math>10^6</math> CFU/ml or greater levels of organisms prior to executing the disinfection process described in chapter 6.4 of the operating instructions.</p>	<p>Test devices achieved the following results:</p> <ul style="list-style-type: none"> <li>● <b>P. aeruginosa:</b> 99.9999% reduction</li> <li>● <b>M. chimaera:</b> 99.9% reduction</li> <li>● <b>M. avium:</b> 99.9% reduction</li> </ul>
<p><b>Water Preservation Effectiveness</b></p> <p>Devices were studied over a 58 week period as follows:</p> <ul style="list-style-type: none"> <li>● Positive controls which did not adhere to chapter 6.6 of the operating instructions (e.g., no use of hydrogen peroxide).</li> <li>● Test devices which did adhere to chapter 6.6 of the operating instructions.</li> </ul>	<p>Test devices achieved the following results:</p> <ul style="list-style-type: none"> <li>● <b>Heterotrophic Plate Counts:</b> <math>\leq 100</math> (CFU) per 1 ml of water</li> <li>● <b>M. chimaera:</b> <math>&lt; 1</math> CFU per 100 ml of water</li> <li>● <b>P. aeruginosa:</b> <math>&lt; 1</math> CFU per 100 ml of water</li> </ul> <p><b>Biofilm formation:</b> Devices maintained per the labeling showed statistically lower viable plate count and qualitatively less surface microbial adhesion than those not maintained per the labeling.</p>

## Aerosol collection set effectiveness

<p><b>Physical Assay</b></p> <p>Devices with the Aerosol Collection Set were studied using aerosol particle sizing (APS) methodology to determine the effectiveness of the ACS and whether it remains functional after 7 days of continued twenty-four (24) hour simulated use.</p>	<p>Aerosol Collection Sets reduced particle emission in excess of 99.0% during the water warming phase and water circuit valve closure phase in the following tests:</p> <ul style="list-style-type: none"> <li>● <b>Vacuum Range Testing:</b> When tested at a range of negative pressures inside the device from 50 Pa to approximately 150 Pa.</li> <li>● <b>ACS Functional Testing:</b> Throughout the 7-day use period.</li> </ul>
<p><b>Microbiological Testing</b></p> <p>Devices with the Aerosol Collection Set were inoculated with at least 10<sup>6</sup> CFU/ml of <i>M. chimaera</i> to determine the effectiveness of the ACS in reducing microbial aerosol emissions. Testing was performed to assure the ACS was effective for 7 days of continued use.</p>	<p>Aerosol Collection Sets reduced NTM emission in excess of 99.9% in the following tests:</p> <ul style="list-style-type: none"> <li>● <b>Vacuum Range Testing:</b> When tested at a range of negative pressures inside the device from 50 Pa to approximately 150 Pa.</li> <li>● <b>ACS Functional Testing:</b> Throughout the 7-day use period.</li> <li>● <b>Filter Testing</b> also demonstrated a &gt; 99.9% reduction of aerosols after passing through the ACS.</li> </ul>

**Note:** To mitigate the potential risks of aerosolization during use:

- ▣ 1 Always use the Aerosol Collection set;
- ▣ 2 Confirm that the heater-cooler vacuum gauge reads greater than 50 Pa with full open vacuum flow applied;
- ▣ 3 Do not empty the external circuits until the patient has been discharged from the OR environment;
- ▣ 4 Always close the external circuits one valve at a time in the order specified.

## 7.1.5 Information about global warming potentials

The cooling circuit of the heater-cooler is filled with a CFC-free HFC- (hydrofluorocarbons) refrigerant. Refer to the device label and chapter 7.2 for further information about the type and volume of the refrigerant.



### Global warming potentials

Refrigerant	R-134/HFC-134a The mixture of the refrigerant may vary.
GWP	1,300 GWP According to IPCCIII (2001/Appendix I): Baseline data in EU F-gas regulation
Active life span	100 years According to IPCCII (1996) source document for the Kyoto protocol

## 7.2 Icons and labels







### 7.2.1 Icons and designations on the nameplates

#### Regulatory symbols and quality marks



 <p>CE 0123</p>	This device complies with the requirements of EU Directive 93/42/EEC of the European Council for Medical Devices.
 <p>TUV SUD C US</p>	Only applies in the U.S.A. and Canada: Certification according to NRTL for Canada (C) and the U.S.A. (US)
 <p>PGT</p>	Only applies in Russia: Certification according to GOST







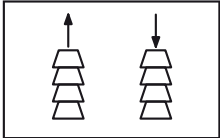
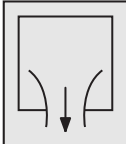

## Additional icons and designations

	Purchase order number
	Serial number
	Date of manufacture
	Manufacturer
	Unique Device Identifier (UDI)
<b>125 kg</b>	Maximum permitted load: A primed and filled heater-cooler must not exceed a total weight of 125 kg.
<b>Rx ONLY</b>	Only applies in the U.S.A.: Sale (and prescription) is restricted to physicians
	Degree of protection against electrical shock: type B
	Protection class I
<b>IPX1</b>	Drip-proof: protected against vertically falling water drops
<b>V ~</b>	Voltage (alternating current)
<b>Hz</b>	Frequency
<b>A</b>	Ampere
<b>kPa</b>	Kilopascal

## 7.2.2 Icons and additional labels on the housing

	<p>Follow instructions for use</p>						
	<p>General warning sign</p>						
	<p>Potential equalization point</p>						
	<p>Outlets and inlets of the patient circuits and cardioplegia circuit</p>						
	<p>Drain valve of the patient circuits Drain valve of the cardioplegia circuit</p>						
<p>This cooling system contains fluorinated greenhouse gases covered by the Kyoto protocol:</p> <table border="1" data-bbox="279 1205 699 1328"> <tr> <td>Refrigerant:</td> <td>R 134a</td> </tr> <tr> <td>Filling charge:</td> <td>1.1 kg</td> </tr> <tr> <td>PS high pressure:</td> <td>18 bar</td> </tr> </table>	Refrigerant:	R 134a	Filling charge:	1.1 kg	PS high pressure:	18 bar	<p>This cooling system contains fluorinated greenhouse gases covered by the Kyoto protocol:</p> <p>Refrigerant (R 134a) (hydrofluorocarbons) Filling charge Pressure switch high pressure</p>
Refrigerant:	R 134a						
Filling charge:	1.1 kg						
PS high pressure:	18 bar						

## 7.2.3 Icons on the packaging

	<p>Fragile item Packaged item is extremely sensitive. Handle with care.</p>
	<p>This side up Always keep in upright position.</p>
	<p>Keep dry Keep out of precipitation.</p>
	<p>Temperature limitation Transport and store within the permissible temperature range.</p>
	<p>Relative humidity limitation Transport and store within the permissible relative humidity range.</p>
	<p>Atmospheric pressure limitation Transport and store within the permissible atmospheric pressure range.</p>

## 7.3 Part numbers

Refer to chapter 6 in these operating instructions for the cleaning and disinfection instructions of reusable products manufactured by LivaNova.

Additionally, refer to chapter 6 for disposal instructions for disposables products manufactured by LivaNova.

For other products that are delivered with separate instructions for use, refer to the manufacturer's instructions on the cleaning and disinfection of reusable accessories and/or for the disposal of specific single-use accessories.

### Heater-Cooler System 3T and electrical components

Part name	Part number	Manufacturer	Use type
Heater-Cooler System 3T (240 V ~ / 60 Hz)	16-02-81	LivaNova	Reusable
Heater-Cooler System 3T (208 V ~ / 60 Hz)	16-02-82	LivaNova	Reusable
Heater-Cooler System 3T (120 V ~ / 60 Hz)	16-02-85	LivaNova	Reusable
CAN cable for connection to the S5/C5 System (including blocking ferrite)	45-12-16	LivaNova	Reusable
Potential equalization cable (5 m)	45-10-50	LivaNova	Reusable

## Other parts

Part name	Part number	Manufacturer	Use type
Tubing connector 1/2", 90° angle	16-10-17*	LivaNova	Reusable
Tubing connector 1/2", straight	73-300-019*	LivaNova	Reusable
Water tubing 1/2", blue (25 m)	75-510-218*	LivaNova	Reusable
Hansen coupling 3/8" for oxygenator, straight, with 1/2" tubing connector	73-300-089*	LivaNova	Reusable
Hansen coupling 3/8" for oxygenator, 90° angle, with 1/2" tubing connector	73-300-090*	LivaNova	Reusable
Short circuit tubing bridge for 3/8" Hansen couplings	73-300-160*	LivaNova	Reusable
3T Aerosol Collection Set	050900100	LivaNova	Disposable with specified use period
1/4" Vacuum extension line with connector	050900111	LivaNova	Disposable with specified use period
Holder for aerosol collection container	005-21-0039	LivaNova	Reusable

\* Applied part according to IEC 60601-1. An applied part is that part of the medical electrical equipment (ME equipment) which in normal use necessarily comes into physical contact with the patient. When the Heater Cooler System 3T is used during an extracorporeal circulation blood is exposed to temperatures from 2°C to 41°C. To prevent damage to the blood by hemolysis, denaturation of proteins and activation of triggers of inflammatory response the temperature during heating shall not exceed 43°C.<sup>1</sup> The blood's resistance to cold temperatures, especially that of the red blood cells, is much higher. Temperatures of 1°C to 4°C are frequently used for blood storage in blood banks.<sup>2</sup>

1 Poder TG, Nonkani WG, Tsakeu Leponkouo É. Blood Warming and Hemolysis: A Systematic Review With Meta-Analysis. *Transfus Med Rev* 2015;29:172-80

2 Yoshida T, Prudent M, D'Alessandro A. Red blood cell storage lesion: causes and potential clinical consequences. *Blood Transfus* 2019;17:27-52

## 7.4 Tested accessories

Compatibility of the Heater-Cooler System 3T with the products listed in the table below has been tested by LivaNova Deutschland GmbH and is thus guaranteed.

The products listed below must be used in compliance with the separate instructions for use provided by the manufacturer. Please refer to the specific products' separate instructions for use for details on the cleaning and disinfection of reusable accessories and/or for the disposal of specific single-use accessories.

<b>Part name</b>	<b>Manufacturer</b>	<b>Use type</b>
Pall-Aquasafe water filter	Pall	Disposable with specified use period
3T Aerosol Collection Set	LivaNova	Disposable with specified use period
1/4" Vacuum extension line with connector	LivaNova	Disposable with specified use period

## 7.5 Warranty

The contractually agreed warranty conditions apply.

## 7.6 Information on electromagnetic compatibility (EMC) according to IEC 60601-1-2 (4th edition)

### 7.6.1 Guidance and manufacturer's declaration

Medical electrical equipment needs precautions regarding electromagnetic compatibility and has to be installed and put into service according to the EMC information provided in the following guidance and the manufacturer's declaration.

Portable and radio frequency (RF) equipment can affect medical electrical equipment.

#### **Essential performance characteristics of the Heater-Cooler System 3T**

Heating and cooling of water:

- Patient tank: 2.0 °C to 41.0 °C
- Cold cardioplegia tank: 2 °C to 10 °C
- Warm cardioplegia tank: 15 °C to 41 °C

The Heater-Cooler System 3T can have a performance degradation, but the basic safety and essential performance will not be influenced.

If the Heater-Cooler System 3T is operated outside the EMC environment specified here, basic safety as well as essential features might fail. In this case, the operator should be aware of a possible risk to the patient.

### Guidance and manufacturer’s declaration – electromagnetic emission

The Heater-Cooler System 3T is intended for use in the professional healthcare facility environment specified below. In order to prevent adverse events to the patient and operator due to electromagnetic disturbances, the Heater-Cooler System 3T must not be operated outside its intended EMC environment. Furthermore, the Heater-Cooler System 3T must not be operated if the enclosure, cables or measures for electromagnetic shielding are damaged.

**Table 1: Emission limits**

Phenomenon	Professional healthcare facility environment	Electromagnetic environment – guidance
Conducted emissions	CISPR 11	Note: The emissions characteristics of this equipment make it suitable for use in industrial areas and hospitals (CISPR 11 class A). If it is used in a residential environment (for which CISPR11 classB is normally required) this equipment might not offer adequate protection to radio-frequency communication services. The user might need to take mitigation measures, such as relocating or reorienting the equipment.
Radiated RF emissions	CISPR 11	
Harmonic distortion	IEC 61000-3-2	
Voltage fluctuations and flicker	IEC 61000-3-3	



### Guidance and manufacturer's declaration – electromagnetic immunity

The Heater-Cooler System 3T is intended for use in the professional healthcare facility environment specified below. In order to prevent adverse events to the patient and operator due to electromagnetic disturbances, the Heater-Cooler System 3T must not be operated outside its intended EMC environment. Furthermore, the Heater-Cooler System 3T must not be operated if the enclosure, cables or measures for electromagnetic shielding are damaged.

**Table 2: Enclosure port**

<b>Phenomenon</b>	<b>Basic EMC standard or test method</b>	<b>Immunity test levels Professional healthcare facility environment</b>
Electrostatic discharge	IEC 61000-4-2	± 8 kV contact ±2 kV, ±4 kV, ±8 kV, ± 15 kV air
Radiated RF EM fields	IEC 61000-4-3	3V/m 80 MHz – 2.7GHz 80% AM at 1kHz
Proximity fields from RF wireless communications equipment	IEC 61000-4-3	See Table 3
Rated power frequency magnetic fields	IEC 61000-4-8	30A/m 50 Hz or 60Hz

### Test specifications for enclosure port immunity to RF wireless communications equipment

Test frequency (MHz)	Band (MHz)	Service	Modulation	Maximum power (W)	Distance (m)	Immunity test level (V/m)
385	380–390	TETRA 400	Pulse modulation 18 Hz	1.8	0.3	27
450	430–470	GMRS 460 FRS 460	FM ±5 kHz deviation 1 kHz sine	2	0.3	28
710	704–787	LTE Band 13, 17	Pulse modulation 217 Hz	0.2	0.3	9
745						
780						
810	800–960	GSM 800/900 TETRA 800 iDEN 820 CDMA 850 LTE Band 5	Pulse modulation 18 Hz	2	0.3	28
870						
930						
1720	1700-1990	GSM 1800 CDMA 1900 GSM 1900 DECT LTE Band 1,3,4, 25 UMTS	Pulse modulation 217 Hz	2	0.3	28
1845						
1970						
2450	2400-2570	Bluetooth WLAN 802.11 b/g/n RFID 2450 LTE Band 7	Pulse modulation 217 Hz	2	0.3	28
5240	5100-5800	WLAN 802.11 a/n	Pulse modulation 217 Hz	0.2	0.3	9
5500						
5785						

Note: If necessary to achieve the immunity test level, the distance between the transmitting antenna and the Heater-Cooler System 3T may be reduced to 1 m. The 1 m test distance is permitted by IEC 61000-4-3.

Note: Portable radio frequency (RF) communications equipment (including peripherals such as antenna cables and external antennas) as well as cables specified by the manufacturer should be used no closer than 30 cm to any part of the Heater-Cooler System 3T. Otherwise this could result in performance degradation of this equipment.

**Table 4: Input AC power port (1 & 2)**

Phenomenon	Basic EMC standard	Immunity test levels
		Professional healthcare facility environment
Electrical fast transients/ bursts	IEC 61000-4-4	± 2 kV 100 kHz repetition frequency
Surges Line-to-line	IEC 61000-4-5	± 0.5 kV, ± 1 kV
Surges Line-to-ground	IEC 61000-4-5	± 0.5 kV, ± 1 kV, ± 2 kV
Conducted disturbances induced by RF fields	IEC 61000-4-6	3 V 0.15 MHz – 80 MHz  6V in ISM bands between 0.15 MHz and 80 MHz  80% AM at 1 kHz
Voltage dips	IEC 61000-4-11	0% $U_T$ ; 0.5 cycle at 0°, 45°, 90°, 135°, 180°, 225°, 270° and 315°
		0% $U_T$ ; 1 cycle and 70% $U_T$ ; 25/30 cycles  Single phase: at 0°
Voltage interruptions	IEC 61000-4-11	0% $U_T$ ; 250/300 cycle

**Table 5: Patient coupling port**

<b>Phenomenon</b>	<b>Basic EMC standard</b>	<b>Immunity test levels</b> <b>Professional healthcare facility environment</b>
Electrostatic discharge	IEC 61000-4-2	± 8 kV contact ±2 kV, ±4 kV, ±8 kV, ± 15 kV air
Conducted disturbances induced by RF fields	IEC 61000-4-6	3 V 0.15 MHz – 80 MHz 6 V in ISM bands between 0.15 MHz and 80 MHz 80% AM at 1 kHz

**Table 6: Signal input ports/signal output ports**

<b>Phenomenon</b>	<b>Basic EMC standard or test method</b>	<b>Immunity test levels</b> <b>Professional healthcare facility environment</b>
Electrostatic discharge	IEC 61000-4-2	± 8 kV contact ±2 kV, ±4 kV, ±8 kV, ± 15 kV air
Electrical fast transients/ bursts	IEC 61000-4-4	± 1 kV 100 kHz repetition frequency
Surges Line-to-ground	IEC 61000-4-5	±2 kV
Conducted disturbances induced by RF fields	IEC 61000-4-6	3 V 0.15 MHz – 80 MHz 6 V in ISM bands between 0.15 MHz and 80 MHz 80% AM at 1 kHz

The emissions limits, IEC 60601 test levels and tests specified by this collateral standard do not address electromagnetic compatibility of electrical equipment at very close distances.

Unless all electrical equipment is compatible with respect to both electric fields and magnetic fields at very close distances over the entire range of expected frequencies, separation is prudent.

If it is essential to use the Heater-Cooler System 3T very close to other electrical equipment, it is prudent to determine, by observation, if the performance of either product is affected by unintended electromagnetic coupling. If this happens, the user is encouraged to try to correct the interference by one or more of the following measures:

- re-orient or relocate the equipment
- increase the amount of space between the equipment
- connect the equipment to separate power sources

Note: If the Heater-Cooler System 3T is operated directly next to other high frequency (HF) surgical devices, this can lead to EMC interference. The HF surgical devices must be observed with increased attention.

## 7.6.2 Technical description

Note: The use of cables other than those specified below may result in increased emissions or decreased immunity of the heater-cooler and/or the heart-lung machine.

For detailed information about cables that may be used for the overall system, please refer to the relevant HLM operating instructions.

Use of cables other than those specified or provided by the manufacturer of this equipment could result in increased electromagnetic emissions or decreased electromagnetic immunity of this equipment and result in improper operation.

<b>Cables/sensors</b>	<b>Length</b>	<b>Part number</b>
Potential equalization cable	5 m	45-10-50
CAN connection cable for the S5/C5 System	6 m	45-12-16



# 8 Troubleshooting

This chapter provides troubleshooting for warnings and error codes you might see on the control panel, and troubleshooting related to the aerosol collection set.

## 8.1 Control panel warnings and error code displays



### WARNING

**Do not use the heater cooler** if the control panel is flashing. This means the heater-cooler is in service mode. Power off the heater-cooler and power it on again to exit service mode.

**NOTE:** LivaNova recommends documenting all maintenance procedures and any operating failures in a medical device log regardless of local regulations. Provide this information to LivaNova when they perform service activities.



## 8.1.1 General errors



Display	Possible cause(s)	Effects	Corrective measures
Display is dark	<ul style="list-style-type: none"> <li>● Defective fuse D 31 (F3)</li> <li>● Defective mains transformer</li> <li>● Defective power pack</li> <li>● Ring main to the display drivers defective</li> <li>● Control system not working</li> </ul>	Affected circuit cannot be operated	Have the heater-cooler checked by your service technician as soon as possible.
Three dashes on one of the actual temperature indicator 7-segment displays 	None	Incorrect or no actual temperature measurement. The affected circuit will not function.	Have the heater-cooler checked by your service technician as soon as possible.

## 8.1.2 Low water level display

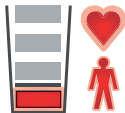
**NOTE:** Refilling the water tanks to maximum water level will have a brief influence upon the actual temperature of all circuits (dependent on the temperature of the refilled water).

Display	Possible cause(s)	Effects	Corrective measures
<p>Water level display's orange segment blinks.</p> 	<p>Preliminary stage of low water level.</p>	<p>This preliminary warning has no direct effect on operation.</p>	<p>Refill solution as quickly as possible. A further decrease of the water level will stop the water circuits.</p>
<p>The water level display's red segment lights up and an audible tone sounds. The corresponding circuit's symbol flashes.</p> 	<p>The minimum water level has been reached.</p>	<p>The corresponding circuit's pump stops.</p>	<p>Refill solution immediately. The water circuit must be restarted manually.</p>

## 8.1.3 High temperature display

Display	Possible cause(s)	Effects	Corrective measures
<p>The symbol of the corresponding patient circuit lights up and an audible tone sounds.</p> 	<p>Maximum deviations between the patient tank's temperature and the water temperature during heating/cooling have been exceeded.</p>	<p>The pumps of the corresponding circuit stop.</p>	<p>You can keep the water circuit running (if necessary) by continuously pressing the corresponding Circuit Start/Stop button. You may wait until the deviation drops within the normal tolerance range again. Then, start the pumps again.</p>
<p>The symbol of the corresponding circuit lights up and an audible tone sounds.</p>  <p>The actual value temperature display shows 41 °C or more.</p>	<ul style="list-style-type: none"> <li>• Temporary temperature deviation during operation.</li> <li>• Excess temperature, defective temperature control.</li> </ul>	<p>The pumps of the corresponding circuit stop.</p>	<ul style="list-style-type: none"> <li>• Wait a short time until the temperature stabilizes at its set temperature, restart the pumps.</li> <li>• You may re-operate the circuit shortly by opening the overflow valve, allowing the water of the corresponding circuit to run out and by refilling it with cold water. However, the temperature control is out of order; for this reason this solution is only suitable for an interim period and if no replacement unit is available.</li> <li>• Contact your service technician and do not use the heater-cooler until repaired.</li> </ul>

## 8.1.4 Error code displays

An error code consists of a series of the capital letter “E” followed by a two-digit number. An error code is usually displayed in the Set Temperatures display of the circuit in which the error has occurred and will stop the function of that circuit. Some error codes are associated with failures affecting all circuits. If such a failure has occurred, the device stops functioning and the corresponding error code is displayed in the Set Temperatures display of the patient circuit.

### How an error code is displayed

Display	Effects
<p>“EE(E)” flashes on one or several 7-segment displays, alternately with an error code. Example:</p> 	<p>Depending on which circuit the error code is displayed in and depending on the error code number, the error has an impact on the function of the respective circuit or on the entire heater-cooler.</p>



#### Important

**During priming, E08, E19, and E23 error codes are normal:** During priming, if you receive error code E08 on the cold cardioplegia circuit display and E19 and E23 on the patient circuit displays, this is normal. These errors appear because air is still in the tubing system (see the full list of error codes below for the exact error code definition). The errors will be resolved once you complete the priming process.

## How to resolve an error code:

To try to clear an error code, perform a “cold start” by powering the heater-cooler off for at least 10 seconds and then powering it back on.

- If the error code is cleared, you may complete the current procedure, but LivaNova strongly recommends the heater-cooler be taken out of service and checked by an authorized service technician as soon as possible.
- If the error code persists, there is a defect and the heater-cooler should not be used. Notify your authorized service technician as soon as possible if you receive error codes other than those present during priming (E08, E19, and E23). All other error codes require attention from an authorized service technician.

## Full list of error code numbers

Display	Description of error cause
E00	<ul style="list-style-type: none"> <li>● Short circuit at control temperature sensor(s)</li> <li>● Short circuit at warm cardioplegia/cold cardioplegia/patient tank</li> </ul>
E01	<ul style="list-style-type: none"> <li>● Interruption at control temperature sensor(s)</li> <li>● Interruption at warm cardioplegia/cold cardioplegia/patient tank</li> </ul>
E02	<ul style="list-style-type: none"> <li>● Short circuit at safety temperature sensor(s)</li> <li>● Short circuit at warm cardioplegia/cold cardioplegia/patient tank</li> </ul>
E03	<ul style="list-style-type: none"> <li>● Interruption at safety temperature sensor(s)</li> <li>● Interruption at warm cardioplegia/cold cardioplegia/patient tank</li> </ul>
E04	The temperature difference between the control and safety systems is too great in one or more tanks (warm cardioplegia tank, cold cardioplegia tank, patient tank).
E05	Power consumption is too low. Pump might not start. The affected component will vary depending on which display presents the error: <ul style="list-style-type: none"> <li>● Patient tank display: stirring mechanism</li> <li>● Cold cardioplegia display: cold cardioplegia pump</li> <li>● Warm cardioplegia display: warm cardioplegia pump</li> </ul>
E06	Pump (stirring mechanism) uses too much power. The affected component will vary depending on which display presents the error: <ul style="list-style-type: none"> <li>● Patient tank display: stirring mechanism</li> <li>● Cold cardioplegia display: cold cardioplegia pump</li> <li>● Warm cardioplegia display: warm cardioplegia pump</li> </ul>

Display	Description of error cause
E07	<p>Pump (stirring mechanism) is blocked. The affected component will vary depending on which display presents the error:</p> <ul style="list-style-type: none"> <li>● Patient tank display: stirring mechanism</li> <li>● Cold cardioplegia display: cold cardioplegia pump</li> <li>● Warm cardioplegia display: warm cardioplegia pump</li> </ul>
E08	<ul style="list-style-type: none"> <li>● Pump (stirring mechanism) is not immersed in liquid. The affected component will vary depending on which display presents the error: <ul style="list-style-type: none"> <li>○ Patient tank display: stirring mechanism</li> <li>○ Cold cardioplegia display: cold cardioplegia pump</li> <li>○ Warm cardioplegia display: warm cardioplegia pump</li> </ul> </li> <li>● There is still air in the external circuit</li> <li>● Incorrect pump configuration of one or more tanks (warm cardioplegia tank, cold cardioplegia tank, patient tank)</li> </ul>
E09	<p>The set temperatures of the control system and safety system are not identical.</p> <p>This error can apply to one or more tanks (warm cardioplegia tank, cold cardioplegia tank, patient tank).</p>
E16	Patient circuit 1 pump does not start (power consumption is too low)
E17	Patient circuit 1 pump uses too much power
E18	Patient circuit 1 pump is blocked (too slow)
E19	<ul style="list-style-type: none"> <li>● Patient circuit 1 pump is not immersed in liquid (rpm is too high)</li> <li>● There is still air in the external circuit</li> </ul>
E20	Patient circuit 2 pump does not start (power consumption is too low)
E21	Patient circuit 2 pump uses too much power (patient circuit 1)
E22	Patient circuit 2 pump is blocked (too slow)
E23	<ul style="list-style-type: none"> <li>● Patient circuit 2 pump is not immersed in liquid (rpm too high)</li> <li>● There is still air in the external circuit</li> </ul>
E24	Short circuit: Temperature sensor on the liquefier
E25	Interruption: Temperature sensor on the liquefier

Display	Description of error cause
E26	Cooler: defective fan cooler or defective rpm sensor (= Hall sensor) <ul style="list-style-type: none"> <li>● Fan: defective motor Symptoms: Fan is not running or is too slow; fan voltage <math>\geq</math> mains voltage</li> <li>● Hardware activation: error (e.g. Triac) Symptoms: Fan is not running or is too slow; fan voltage <math>\geq</math> mains voltage</li> <li>● No or incorrect speed measurement: (e.g. Hall sensor) Symptoms: Defective Hall sensor; fan speed too high (1,300 ... 1,500 rpm)</li> </ul>
E27	Cooler: Pressure switch tripped (part of the compressor circuit) If the pressure is too high, the compressor is switched off.
E28	Cooler: Excess temperature switch tripped (Klixon, located in the compressor junction box). If the temperature of the compressor is too high, compressor is switched off.
E29	Start test: Stuck key detected
E30	Safety system: Program run error; communication problems between the control and safety systems
E31	Start test: No supply synchronization possible
E32	EEPROM module: Defective or cannot be accessed
E33	Start test (control system): Data in the EEPROM is defective
E34	Start test (safety system): Data in the EEPROM is defective
E35	Safety system: EEPROM write test failed
E36	Start test: Cannot access CAN controller
E37	Start test: Cannot access display drivers
E38	Start test (control system): ROM checksum error
E39	Start test (control system): RAM error
E40	Start test (control system): CPU error
E41	Start test (safety system): ROM checksum error
E42	Start test (safety system): RAM error
E43	Start test (safety system): CPU error
E44	Safety system: Control system does not respond
E45	Safety system: 5 V control system not within the tolerated range
E46	Control system: Safety system does not respond
E47	Control system: 5 V safety system is not within the tolerated range
E48	Start test: All relays and Triacs are open, current too high
E49	Start test (warm cardioplegia): Relay does not open

<b>Display</b>	<b>Description of error cause</b>
E50	Start test (warm cardioplegia): Triac does not open
E51	<ul style="list-style-type: none"> <li>● Start test (warm cardioplegia): Relay or Triac does not close</li> <li>● Start test for warm cardioplegia heating interrupted</li> </ul>
E52	Start test (warm cardioplegia): Heating uses too much power
E53	Start test (patient tank): Relay does not open
E54	Start test (patient tank): Triac 1 does not open
E55	<ul style="list-style-type: none"> <li>● Start test (patient tank): Relay or Triac 1 does not close</li> <li>● Start test (patient tank): Heating 1 interrupted</li> </ul>
E56	Start test (patient tank): Heating 1 uses too much power
E57	Start test (patient tank): Triac 2 does not open
E58	<ul style="list-style-type: none"> <li>● Start test (patient tank): Relay or Triac 2 does not close</li> <li>● Start test (patient tank): Heating 2 interrupted</li> </ul>
E59	<ul style="list-style-type: none"> <li>● Start test (patient tank): Heating 2 uses too much power</li> <li>● Pumps operate with a continually fluctuating rotational speed</li> </ul>



## 8.2 Troubleshooting or returning the 3T Aerosol Collection Set

### 8.2.1 Troubleshooting for the aerosol collection set

Problem	Possible cause(s)	Corrective measures
Vacuum does not exceed 50 Pa when vacuum is first applied	Vacuum regulator not set to maximum	Adjust vacuum regulator to full open vacuum
	Vacuum source line is detached or kinked	Reconnect and/or unkink vacuum line
	HC3T connection line is detached or kinked	Reconnect and/or unkink HC3T connection line
	ACS lid filter is blocked	Replace ACS according to chapter 5.7.2
	ACS caps are not tight	Secure caps over the pour spout and tandem port
	ACS lid is not tight	Secure ACS lid to canister around the entire perimeter of the lid
	Filler neck cap is removed or loose	<ul style="list-style-type: none"> <li>● Secure filler neck cap</li> <li>● Check filler neck and cap sealing surfaces for debris</li> <li>● Contact LivaNova for a replacement cap</li> </ul>
Circuit tanks are empty (allowing air to enter via the circuit inlets)	<ul style="list-style-type: none"> <li>● Fill tanks and recheck vacuum</li> <li>● Connect procedural tubing and recheck vacuum</li> </ul>	

Problem	Possible cause(s)	Corrective measures
Continued: Vacuum does not exceed 50 Pa when vacuum is first applied	Internal vacuum line is blocked	<ul style="list-style-type: none"> <li>▣ 1 Remove service port cap (white Luer fitting) on the side of the vacuum gauge</li> <li>▣ 2 Set vacuum regulator to maximum</li> <li>▣ 3 Replace service port cap</li> <li>▣ 4 Set vacuum regulator to off</li> <li>▣ 5 Remove service port cap (white Luer fitting) on the side of the vacuum gauge</li> <li>▣ 6 Apply air pressure through the service port using a 30 cc or larger sterile syringe</li> <li>▣ 7 Replace service port cap</li> </ul>
	Vacuum gauge failure	Contact your LivaNova service technician
Vacuum drops below 50 Pa during the procedure	Overflow safety trap (“water trap”) in the vacuum line is full	Empty the overflow safety trap Replace overflow safety trap with a larger unit (i.e. Ohio Medical 275 mL Collection Bottle with 1/8" NPT Locking Gland)
	ACS is completely filled with water	Empty the ACS per chapter 5.7.2
	Vacuum source line is detached or kinked	Reconnect and/or unkink vacuum source line
	HC3T connection line is detached or kinked	Reconnect and/or unkink HC3T connection line  If vacuum is still low, the lid filter may be blocked. Replace the ACS per chapter 4.5.
Excessive condensation in the safety overflow trap	Operation in humid climates increases the volume of condensation	Contact LivaNova for information on a larger safety overflow trap

## 8.2.2 Returning a used aerosol collection container

### For customers within the United States

- ▣ 1 Obtain a returned goods authorization (RGA) number from LivaNova USA, Inc. prior to returning the 3T Aerosol Collection Set.
- ▣ 2 Clean and disinfect the aerosol collection container if it has been in contact with blood or body fluids.



### CAUTION

**Do not** return products that have been exposed to blood-borne infectious diseases. It is the responsibility of the healthcare institution to adequately prepare and identify the product for return shipment.

To ship the aerosol collection container:

- ▣ 1 Package the aerosol collection container in either the original carton or an equivalent carton to prevent damage during shipment
- ▣ 2 Label the carton with the RGA number and an indication of the biohazardous nature of the contents of the shipment.
- ▣ 3 Ship the aerosol collection container to the following address:  
LivaNova USA, Inc.  
Returned CV Products  
14401 West 65th Way  
Arvada, CO 80004-3599

Instructions for cleaning and materials, including appropriate shipping containers, proper labeling, and an RGA number may be obtained from the LivaNova USA, Inc. Returned Goods Coordinator, Quality Assurance Department (phone: 800-650-2623).

### **For customers outside the United States:**

Contact your sales representative for specific instructions.

Clean and disinfect the aerosol collection container if it has been in contact with blood or body fluids.



#### **CAUTION**

**Do not** return products that have been exposed to blood-borne infectious diseases. It is the responsibility of the healthcare institution to adequately prepare and identify the product for return shipment.